

# SERVICE MANUAL



**HBU-18CF03**



**HDU-42CF03/H**

**HPU-42HF03**

### Model

#### ● Features

- Long distribution pipe and high drop
- Auto-check function
- Flexible and easy installation
- Fresh air hole, more natural, more healthy
- Infrared remote controller & wired controller
- Optional safety devices and much more precision control device



## CONTENTS

|  |    |
|--|----|
| Contents.....                                      | 2  |
| 1. Description of products & features.....         | 3  |
| 2. Specification.....                              | 7  |
| 3. Safety precaution.....                          | 11 |
| 4. Net dimension of indoor and outdoor.....        | 13 |
| 5. Installation instructions.....                  | 16 |
| 6. Parts and functions.....                        | 37 |
| 7. Remote controller functions.....                | 40 |
| 8. Refrigerant diagram.....                        | 61 |
| 9. Electrical control functions.....               | 64 |
| 10. Diagnostic information (trouble shooting)..... | 70 |
| 11. Electrical data.....                           | 74 |
| 12. Air velocity distribution.....                 | 88 |

## 1. DESCRIPTION OF PRODUCTS & FEATURES

### 1.1. Products code explanation

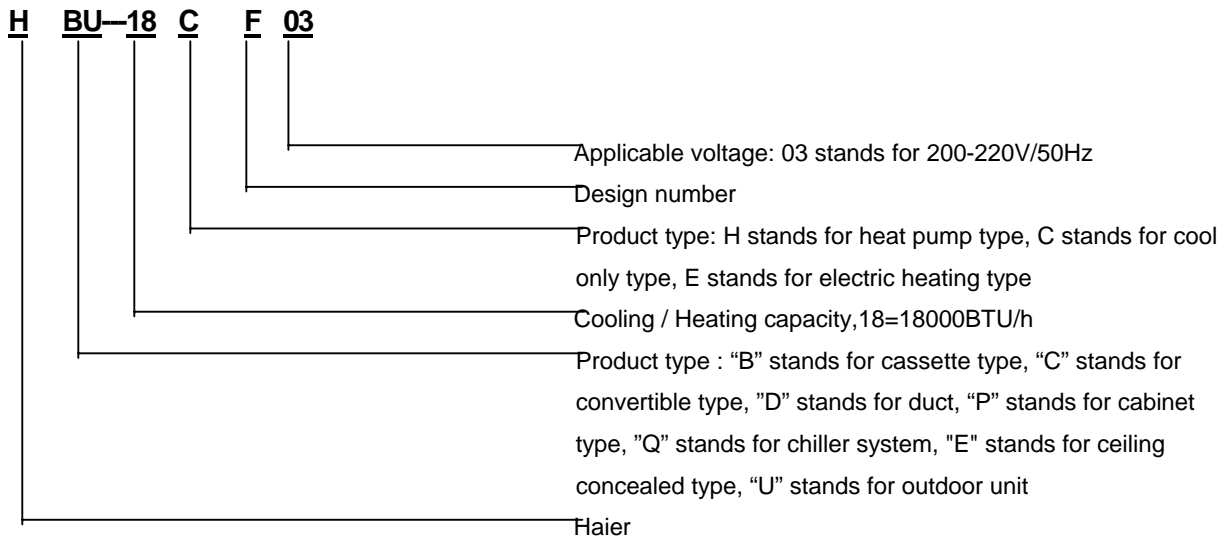

### 1.2 Brief Introduction for T1、T2、T3 working condition

| Type of Air Conditioner | Climate type |           |           |
|-------------------------|--------------|-----------|-----------|
|                         | T1           | T2        | T3        |
| Cooling Only            | 18 °C~43°C   | 10°C~35°C | 21°C~52°C |
| Heat pump               | -7°C~43°C    | -7°C~35°C | -7°C~52°C |
| Electricity Heating     | ~43°C        | ~35°C     | ~52°C     |

### 1.3 Operating Range of Air Conditioners

| Temp.   |         | Mode  | Rated | Maximum | Minimum |
|---------|---------|-------|-------|---------|---------|
| Cooling | Indoor  | DB °C | 27    | 32      | 15      |
|         |         | WB °C | 19    | 23      | 14      |
|         | Outdoor | DB °C | 35    | 43      | -5      |
|         |         | WB °C | 24    | 26      | 6       |
| Heating | Indoor  | DB °C | 20    | 27      | 10      |
|         |         | WB °C | 14.5  | ---     | --      |
|         | Outdoor | DB °C | 7     | 23      | -10     |
|         |         | WB °C | 6     | 18      | ---     |

### 1.4 Products line up

|   |  |  |
|---|--|--|
|  |  |   |
|  |  |  |
| HBU-18CF03  | HDU-42CF03/H   | HPU-42HF03   |

### 1.5 Product features

#### 1.5.1 Outdoor unit .

##### Flexible and easy installation

The outdoor can meet the higher request of installation. From the specifications, you will find for each unit, how long and how high the piping will be, which will be convenient for design and installation.

##### Optional safety devices and much more precision control device

- a. Ambient **temperature sensor**, coil temperature sensor and compressor temperature sensor make the temperature control and defrosting control more precise.
- b. **High/low pressure switch** can feel the discharging pipe pressure and suction pipe pressure on time and precisely. If the pressure is too low or too high, it will stop the compressor to prevent it being damaged for the sake of pressure.
- c. **3 minutes delay protection** for the compressor, the device can protect the compressor from some damages and make the compressor have a long life.

##### Silent operation

##### New design of long piping length and large drop

## 1.5.2 Indoor unit

### 1.5.2.1 Noblest cassette indoor unit

#### Compact indoor unit body

The dimension of indoor unit is 570×570×260, convenient for installation in the ceiling, perfectly match with the decor of indoor decoration and be in accordance with the standard of aesthetics.

#### Fresh air inlet hole

The cassette indoor unit is equipped with a fresh air hole, from which you can get the fresh air from the outdoor, to improve the indoor air quality. More natural and more healthier.

#### Convenient infrared remote controller

The newly designed infrared remote controller YR-H71 can be used for all indoor units of single type, multi split type, and H-MRV type except for the cabinet unit. This controller can be compatible with all old remote controllers except for that of cabinet units.

#### Auto-check function

The unit can display the malfunction codes on the control board by using advanced auto-check technology, convenient for user find and dwell with the abnormal running.

#### Built-in high head drain water pump

Due to the internal float switch, built-in drain water pump can drain water automatically when the condensation is full enough and necessary to be cleaned, the standard head height can be up to 600mm, realizing the most effective water drainage.

#### Quiet operation

The unit is equipped with the greatly powerful, smooth, and ultra quiet multi-blade fan, which has the irregular helix, and can run in silence.

### 1.5.2.2 Elegant duct indoor unit

#### Space saving design

With the minimum thickness of only 225mm, the unit almost can be installed into any ducted space. It needs not the very big space, and will not effect the exterior decoration, only leave people comfortable air not feeling its existence.

#### High efficiency filter

The unit adopts G3 grade filter, can efficiently filter the dirt etc, and improve the room air quality, at the same time, the filter can pull out from downside, convenient for maintenance and cleaning.

#### Multi-mode for installation

The indoor unit can be installed with or without an air return duct according to the installation need.

### **Free setting of air discharging duct**

The number of the airflow outlet and its installation position can be freely selected according to the environment of the room, sufficiently considering the load of the room and the uniform temperature of the room to realize more perfect comfort.

### **High esp design**

Max. external static pressure of 196 Pa brings the quick temperature adjustment to the room. Adopts high pressure fan to provide quick speed of air blowing while keeping a low sound level and ensuring a good air circulation of the whole indoor space.

### **Ultra high head water drain up**

The duct unit adopt the water pump, which can be up to 600mm.

## 1.5.2.3 Steady cabinet indoor unit

### **Powerfull running & long distance air sending**

The unit can run powerfully and supply large volume of cooled air to the room. Long distance and large angle air sending ensures average temperature distribution, bring you much more comfortable indoor environment in the shortest time.

### **Newly designed display panel, more simple**

On the display panel there are power, operation, timer, and electric heating indicator, from which you can find the operation state directly, and the indicator flash times can show the failure.

### **Malfunction Auto-checking**

Failure codes displayed by LED or controllers are so detailed for us to find the fail place more quickly, and can judge the failure content easily.

### **Powerfull/Soft function**

Special button on remoto controller is used to set powerful working or soft working.

### **Single fan outdoor, more compact**

### **Central control function, if connected with a detector and a central controller**

### 2. Specification

| item   |                                      | Model                       |             | HBU-18CF03                 |             |  |
|--|--------------------------------------|-----------------------------|-------------|----------------------------|-------------|--|
| Function   |                                      |                             |             | cooling                    | heating     |  |
| Capacity   |                                      |                             | BTU/h       | 17000                      | /           |  |
| Capacity   |                                      |                             | kW          | 5                          | /           |  |
| Sensible heat ratio  |                                      |                             |             | 75%                        | /           |  |
| Total power input  |                                      |                             | W           | 1780                       | /           |  |
| Max. power input   |                                      |                             | W           | 2400                       | /           |  |
| EER or COP   |                                      |                             | W/W         | 2.81                       | /           |  |
| Dehumidifying capacity   |                                      |                             | 10 - ³xm³/h | 1.6                        |             |  |
| Power cable  |                                      |                             | section     | 3×2.5mm2                   |             |  |
| Signal cable   |                                      |                             | section     | 3×2.0mm2                   |             |  |
| Connecting cable   |                                      |                             | section     |                            |             |  |
| Wired control cable  | for wired control unit               |                             | section     | /                          | /           |  |
| Power source   |                                      |                             | N, V, Hz    | 1,220-230,50               |             |  |
| Running /Max.Running   |                                      |                             | A / A       | 8.2/11.0                   |             |  |
| Start Current  |                                      |                             | A           | 40                         |             |  |
| Class of anti electric shock   |                                      |                             |             | /                          | /           |  |
| Circuit breaker  |                                      |                             | A           | /                          | 30          |  |
| Max. operating pressure of heat side   |                                      |                             | Mpa         | 2.94                       |             |  |
| Max. operating pressure of cold side   |                                      |                             | Mpa         | 2.94                       |             |  |
| Unit model (color)   |                                      | HBU-18HF03(INDOOR) (WHITE)  |             |                            |             |  |
| Indoor unit  | Fan                                  | Type × Number               |             | Centrifugal×1              |             |  |
|  |                                      | Speed(H-M-L)                | r/min       | 750±20/650±30/520±30       |             |  |
|  |                                      | Fan motor output power      | kW          | 0.055                      |             |  |
|  |                                      | Air-flow(H-M-L)             | m³/h        | 670                        |             |  |
|  | Heat exchanger                       | Type / Diameter             |             | mm                         |             |  |
|  |                                      | Total Area                  | m²          | /                          |             |  |
|  |                                      | Temp. scope                 | °C          | cooling: 43-60 heating:6-7 |             |  |
|  | Dimension                            | External                    | (L×W×H)     | mm×mm×mm                   | 570×570×260 |  |
|  |                                      | Package                     | (L×W×H)     | mm×mm×mm                   | 718×680×380 |  |
|  | Air sending angle                    |                             |             | /                          | /           |  |
|  | Drainage pipe (material , I.D./O.D.) |                             | mm          | /                          |             |  |
|  | Control type (Remote /wired /model)  |                             |             | REMOTE                     |             |  |
|  | Fresh air hole dimension             |                             | mm          | /                          |             |  |
|  | Outlet distribution hole dimension   |                             | mm          | /                          |             |  |
| Electricity Heater   |                                      | kW                          | /           |                            |             |  |
| Noise level (H-M-L)  |                                      | dB(A)                       | 45/40/32    |                            |             |  |
| Weight (Net / Shipping)  |                                      | kg / kg                     | 25/27       |                            |             |  |
| Panel  | Dimension                            | External                    | (L×W×H)     | 700×700×60                 |             |  |
|  |                                      | Package                     | (L×W×H)     | 740×750×115                |             |  |
|  | Weight (Net / Shipping)              |                             | kg / kg     | 3.5/4.5                    |             |  |
| Unit model (color)   |                                      | HBU-18CF03(OUTDOOR) (WHITE) |             |                            |             |  |
| Outdoor unit   | Compressor                           | Model / Manufacture         |             | TH338VEEC MITSUBISHI       |             |  |
|  |                                      | Oil model                   |             | DIAMOND MS-56              |             |  |
|  |                                      | Oil type                    |             | /                          |             |  |
|  |                                      | Oil charging                |             | 520                        |             |  |
|  |                                      | Type                        |             | ROTARY                     |             |  |
|  |                                      | Protection type             |             | inset protector            |             |  |
|  | Starting method                      |                             | force start |                            |             |  |
|  | Fan                                  | Type × Number               |             | Axial × 1                  |             |  |
|  |                                      | Speed                       | r/min       | 860±30                     |             |  |
|  |                                      | Fan motor output power      | kW          | 0.03                       |             |  |
|  |                                      | Air-flow(H-M-L)             | m³/h        | 2500                       |             |  |
|  | Heat exchanger                       | Type / Diameter             |             | mm                         |             |  |
|  |                                      | Row / Fin pitch             |             | /                          |             |  |
|  | Dimension                            | External                    | (L×W×H)     | mm×mm×mm                   | 815×340×680 |  |
|  |                                      | Package                     | (L×W×H)     | mm×mm×mm                   | 960×406×750 |  |
|  | Drainage pipe (material , I.D./O.D.) |                             | mm          | /                          |             |  |
|  | Refrigerant control method           |                             | mm/mm       | Capillary tube             |             |  |
|  | Defrosting                           |                             |             | Automatic                  |             |  |
| Volume of Accumulator  |                                      | L                           | /           |                            |             |  |
| Noise level  |                                      | dB(A)                       | 56          |                            |             |  |
| Type of Four way valve   |                                      |                             | /           |                            |             |  |
| material of reduce noise   |                                      |                             | /           |                            |             |  |
| crankcase heater power   |                                      | W                           | /           |                            |             |  |
| Weight (Net / Shipping)  |                                      | kg / kg                     | 53/56       |                            |             |  |
| PIPING   | Refrigerant                          | Type / Charge               | g           | R22/1800                   |             |  |
|  |                                      | Recharge quantity           | g/m         | /                          |             |  |
|  | Pipe                                 | Liquid                      | mm          | 6.35                       |             |  |
|  |                                      | Gas                         | mm          | 12.7                       |             |  |
|  | Connecting Method                    |                             |             | Flared                     |             |  |
| Between I.D & O  | MAX.Drop                             | m                           | 5           |                            |             |  |
|  | MAX.Piping length                    | m                           | 15          |                            |             |  |
| Normal condition: indoor temperature (cooling): 27 °CDB/19 °CWB, indoor temperature (heating): 20 °CDB   |                                      |                             |             |                            |             |  |
| Outdoor temperature(cooling): 35 °CDB/24 °CWB, outdoor temperature(heating): 7 °CDB/6 °CWB   |                                      |                             |             |                            |             |  |
| The noise level will be measured in the third octave band limited values, using a Real Time Analyser calibrated sound intensity meter. It is a sound pressure noise level. |                                      |                             |             |                            |             |  |

| item   | Model                                |                        | HDU-42CF03/H                 |                               |   |
|--|--------------------------------------|------------------------|------------------------------|-------------------------------|---|
| Function   |                                      |                        | cooling                      | heating                       |   |
| Capacity   |                                      | BTU/h                  | 42600                        | /                             |   |
| Capacity   |                                      | kW                     | 12.5                         | /                             |   |
| Sensible heat ratio  |                                      |                        | 75%                          | /                             |   |
| Total power input  |                                      | W                      | 4700                         | /                             |   |
| Max. power input   |                                      | W                      | 5700                         | /                             |   |
| EER or COP   |                                      | W/W                    | 2.66                         | /                             |   |
| Dehumidifying capacity   |                                      | 10 - ³m³/h             | 5.0                          |                               |   |
| Power cable  |                                      | section                | 5x2.5mm²                     |                               |   |
| Signal cable   |                                      | section                | 4x0.75mm²                    |                               |   |
| Connecting cable   |                                      | section                | 4x0.75mm²                    |                               |   |
| Wired control cable  | for wired control unit               | section                | /                            | 4x0.33mm²屏蔽线                  |   |
| Power source   |                                      | N, V, Hz               | 3, 380-400, 50               |                               |   |
| Running /Max.Running   |                                      | A / A                  | cooling 8.2/9.5              |                               |   |
| Start Current  |                                      | A                      | 50                           |                               |   |
| Class of anti electric shock   |                                      |                        | I                            | /                             |   |
| Circuit breaker  |                                      | A                      | /                            | 30                            |   |
| Max. operating pressure of heat side   |                                      | Mpa                    | 2.8                          |                               |   |
| Max. operating pressure of cold side   |                                      | Mpa                    | 0.8                          |                               |   |
| Indoor unit  | Unit model (color)                   |                        | HDU-42CF03/H(INDOOR) (WHITE) |                               |   |
|  | Fan                                  | Type x Number          | Centrifugal x 1              |                               |   |
|  |                                      | Speed(H-M-L)           | r/min                        | 1070±30/950±40/860±50/690±50  |   |
|  |                                      | Fan motor output power | kW                           | 0.27                          |   |
|  |                                      | Air-flow(H-M-L)        | m³/h                         | 2040                          |   |
|  | Heat exchanger                       | Type / Diameter        | mm                           | TP2M / 9.52x0.36              |   |
|  |                                      | Total Area             | m²                           | /                             |   |
|  |                                      | Temp. scope            | °C                           | cooling: 43-60 / heating: 6-7 |   |
|  | Dimension                            | External (LxWxH)       | mmxmmxmm                     | 1197x828x355                  |   |
|  |                                      | Package (LxWxH)        | mmxmmxmm                     | 1450x980x530                  |   |
|  | Air sending angle                    |                        | /                            | /                             |   |
|  | Drainage pipe (material , I.D./O.D.) | mm                     | /                            |                               |   |
|  | Control type (Remote /wired /model)  |                        | wired                        |                               |   |
|  | Fresh air hole dimension             | mm                     | /                            |                               |   |
|  | Outlet distribution hole dimension   | mm                     | /                            |                               |   |
|  | Electricity Heater                   | kW                     | /                            |                               |   |
|  | Noise level (H-M-L)                  | dB(A)                  | 55/52/47                     |                               |   |
|  | Weight (Net / Shipping)              | kg / kg                | 62/77                        |                               |   |
|  | Panel                                | Dimension              | External (LxWxH)             | mmxmmxmm                      | / |
|  |                                      | Package (LxWxH)        | mmxmmxmm                     | /                             |   |
| Weight (Net / Shipping)  |                                      | kg / kg                | /                            |                               |   |
| Outdoor unit   | Unit model (color)                   |                        | HDU-42HF03/H(INDOOR) (WHITE) |                               |   |
|  | Compressor                           | Model / Manufacture    | JT160BCBY1L DAKIN            |                               |   |
|  |                                      | Oil model              | SUNISO 4GSDID-K/DAPHNE SE56P |                               |   |
|  |                                      | Oil type               | /                            |                               |   |
|  |                                      | Oil charging           | 1500-1700                    |                               |   |
|  |                                      | Type                   | SCROLL                       |                               |   |
|  |                                      | Protection type        | 内置保护器                        |                               |   |
|  | Starting method                      | 硬启动                    |                              |                               |   |
|  | Fan                                  | Type x Number          | Axial x 1                    |                               |   |
|  |                                      | Speed                  | r/min                        | 740±50                        |   |
|  |                                      | Fan motor output power | kW                           | 0.156                         |   |
|  |                                      | Air-flow(H-M-L)        | m³/h                         | 6000                          |   |
|  | Heat exchanger                       | Type / Diameter        | mm                           | TP2M / 9.52x0.36              |   |
|  |                                      | Row / Fin pitch        |                              | 2 1.65                        |   |
|  |                                      | Temp. scope            | °C                           | cooling: 43-60 / heating: 6-7 |   |
|  | Dimension                            | External (LxWxH)       | mmxmmxmm                     | 1008x830x480                  |   |
|  |                                      | Package (LxWxH)        | mmxmmxmm                     | 1130x930x490                  |   |
|  | Drainage pipe (material , I.D./O.D.) | mm                     | /                            |                               |   |
|  | Refrigerant control method           | mm/mm                  | Capillary tube               |                               |   |
|  | Defrosting                           |                        | Automatic                    |                               |   |
| Volume of Accumulator  | L                                    | /                      |                              |                               |   |
| Noise level  | dB(A)                                | 64                     |                              |                               |   |
| Type of Four way valve   |                                      | /                      |                              |                               |   |
| material of reduce noise   |                                      | /                      |                              |                               |   |
| crankcase heater power   | W                                    | /                      |                              |                               |   |
| Weight (Net / Shipping)  | kg / kg                              | 75/85                  |                              |                               |   |
| PIPING   | Refrigerant                          | Type / Charge          | g                            | R22/3150                      |   |
|  |                                      | Recharge quantity      | g/m                          | /                             |   |
|  | Pipe                                 | Liquid                 | mm                           | 9.52                          |   |
|  |                                      | Gas                    | mm                           | 19.05                         |   |
|  | Connecting Method                    |                        | Flared                       |                               |   |
| Between I.D & O  | MAX.Drop                             | m                      | 30                           |                               |   |
|  | MAX.Piping length                    | m                      | 50                           |                               |   |
| Nominal condition: indoor temperature (cooling): 27 °CDB/19°CWB, indoor temperature (heating): 20 °CDB<br>Outdoor temperature(cooling): 35 °CDB/24°CWB, outdoor temperature(heating): 7 °CDB/6 °CWB<br>The noise level will be measured in the third octave band limited values, using a Real Time Analyser calibrated sound intensity meter. It is a sound pressure noise level. The detailed method please refer to the following information: |                                      |                        |                              |                               |   |



| item                                 | Model                                |                        | HPU-42HF03                  |                                 |              |
|--------------------------------------|--------------------------------------|------------------------|-----------------------------|---------------------------------|--------------|
| Function                             |                                      |                        | cooling                     | heating                         |              |
| Capacity                             |                                      |                        | 41000                       | 44000                           |              |
| Capacity                             |                                      |                        | kW                          | 12                              |              |
| Sensible heat ratio                  |                                      |                        | 75%                         | /                               |              |
| Total power input                    |                                      |                        | W                           | 4700                            |              |
| Max. power input                     |                                      |                        | W                           | 5200                            |              |
| EER or COP                           |                                      |                        | W/W                         | 2.55                            |              |
| Dehumidifying capacity               |                                      |                        | 10 - ³x³/h                  | 5.0                             |              |
| Power cable                          |                                      |                        | section                     | 5x2.5mm²                        |              |
| Signal cable                         |                                      |                        | section                     | 6x0.75mm²                       |              |
| Connecting cable                     |                                      |                        | section                     |                                 |              |
| Wired control cable                  |                                      | for wired control unit | section                     | / /                             |              |
| Power source                         |                                      |                        | N, V, Hz                    | 3, 380-400, 50                  |              |
| Running /Max.Running                 |                                      |                        | A / A                       | cooling 8.5/9.3 heating 8.8/9.6 |              |
| Start Current                        |                                      |                        | A                           | 50                              |              |
| Class of anti electric shock         |                                      |                        |                             | I                               |              |
| Circuit breaker                      |                                      |                        | A                           | 30                              |              |
| Max. operating pressure of heat side |                                      |                        | Mpa                         | 2.8                             |              |
| Max. operating pressure of cold side |                                      |                        | Mpa                         | 2.8                             |              |
| Indoor unit                          | Unit model (color)                   |                        | HPU-42HF03(INDOOR) (WHITE)  |                                 |              |
|                                      | Fan                                  | Type x Number          |                             | Centrifugal x 1                 |              |
|                                      |                                      | Speed(H-M-L)           |                             | 590±30/400±40/350±50            |              |
|                                      |                                      | Fan motor output power |                             | kW                              |              |
|                                      |                                      | Air-flow(H-M-L)        |                             | m³/h                            |              |
|                                      | Heat exchanger                       | Type / Diameter        |                             | mm                              |              |
|                                      |                                      | Total Area             |                             | m²                              |              |
|                                      |                                      | Temp. scope            |                             | °C                              |              |
|                                      | Dimension                            | External               | (LxWxH)                     | mmxmmxmm                        | 1820x530x310 |
|                                      |                                      | Package                | (LxWxH)                     | mmxmmxmm                        | 1900x620x415 |
|                                      |                                      | Air sending angle      |                             | / /                             |              |
|                                      | Drainage pipe (material , I.D./O.D.) |                        | mm                          |                                 |              |
|                                      | Control type (Remote /wired /model)  |                        | REMOTE                      |                                 |              |
|                                      | Fresh air hole dimension             |                        | mm                          |                                 |              |
|                                      | Outlet distribution hole dimension   |                        | mm                          |                                 |              |
|                                      | Electricity Heater                   |                        | kW                          |                                 |              |
|                                      | Noise level (H-M-L)                  |                        | dB(A)                       |                                 |              |
|                                      | Weight (Net / Shipping)              |                        | kg / kg                     |                                 |              |
| Panel                                | Dimension                            | External               | (LxWxH)                     | mmxmmxmm                        |              |
|                                      | Package                              | (LxWxH)                | mmxmmxmm                    | /                               |              |
|                                      | Weight (Net / Shipping)              |                        | kg / kg                     |                                 |              |
| Outdoor unit                         | Unit model (color)                   |                        | HPU-42HF03(OUTDOOR) (WHITE) |                                 |              |
|                                      | Compressor                           | Model / Manufacture    |                             | JT160BCBY1L DAKIN               |              |
|                                      |                                      | Oil model              |                             | SUNISO 4GSDID-K/DAPHNE SE56P    |              |
|                                      |                                      | Oil type               |                             | /                               |              |
|                                      |                                      | Oil charging           |                             | 1500-1700                       |              |
|                                      |                                      | Type                   |                             | SCROLL                          |              |
|                                      |                                      | Protection type        |                             | inset protector                 |              |
|                                      | Fan                                  | Starting method        |                             | force start                     |              |
|                                      |                                      | Type x Number          |                             | Axial x 1                       |              |
|                                      |                                      | Speed                  |                             | r/min                           |              |
|                                      |                                      | Fan motor output power |                             | kW                              |              |
|                                      |                                      | Air-flow(H-M-L)        |                             | m³/h                            |              |
|                                      |                                      | Type / Diameter        |                             | mm                              |              |
|                                      | Heat exchanger                       | Row / Fin pitch        |                             | 2 1.65                          |              |
|                                      |                                      | Temp. scope            |                             | °C                              |              |
|                                      |                                      | Temp. scope            |                             | cooling: 43~60 / heating: 6~7   |              |
|                                      | Dimension                            | External               | (LxWxH)                     | mmxmmxmm                        | 1006x825x410 |
|                                      |                                      | Package                | (LxWxH)                     | mmxmmxmm                        | 1130x930x490 |
|                                      | Drainage pipe (material , I.D./O.D.) |                        | mm                          |                                 |              |
|                                      | Refrigerant control method           |                        | mm/mm                       |                                 |              |
|                                      | Defrosting                           |                        | Automatic                   |                                 |              |
|                                      | Volume of Accumulator                |                        | L                           |                                 |              |
|                                      | Noise level                          |                        | dB(A)                       |                                 |              |
|                                      | Type of Four way valve               |                        | /                           |                                 |              |
| material of reduce noise             |                                      | /                      |                             |                                 |              |
| crankcase heater power               |                                      | W                      |                             |                                 |              |
| Weight (Net / Shipping)              |                                      | kg / kg                |                             |                                 |              |
| PIPING                               | Refrigerant                          | Type / Charge          | g                           |                                 |              |
|                                      |                                      | Recharge quantity      | g/m                         |                                 |              |
|                                      | Pipe                                 | Liquid                 | mm                          |                                 |              |
|                                      |                                      | Gas                    | mm                          |                                 |              |
|                                      | Connecting Method                    |                        | Flared                      |                                 |              |
| Between I.D & O                      | MAX.Drop                             | m                      |                             |                                 |              |
|                                      | MAX.Piping length                    | m                      |                             |                                 |              |

**Installation state:** the unit should be placed on the flat floor or be mounted in horizontal direction.

**Testing method:**

standing-on-floor unit: If the unit cooling capacity is over 28000W, the noise level should be measured at the front, left, right directions respectively.

built-in-ceiling unit:

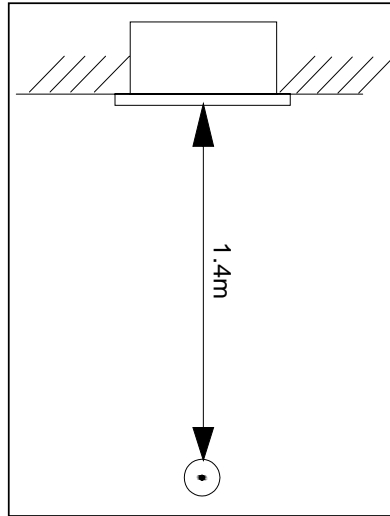
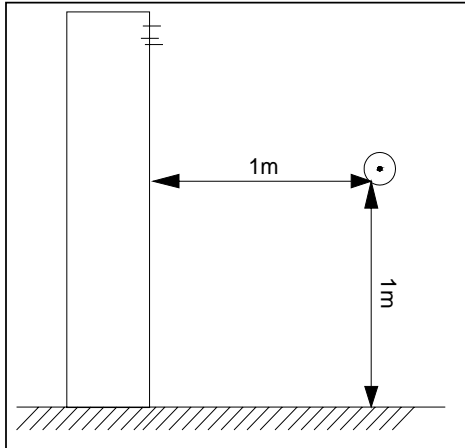

duct unit without auxiliary duct:

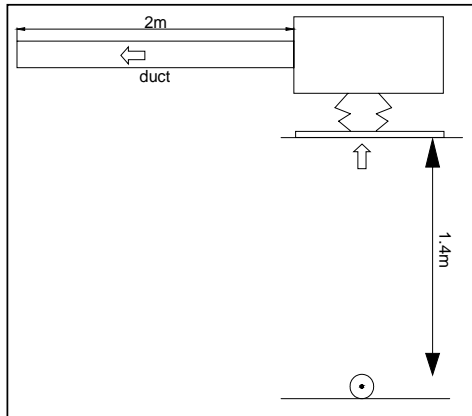

duct unit with auxiliary duct:

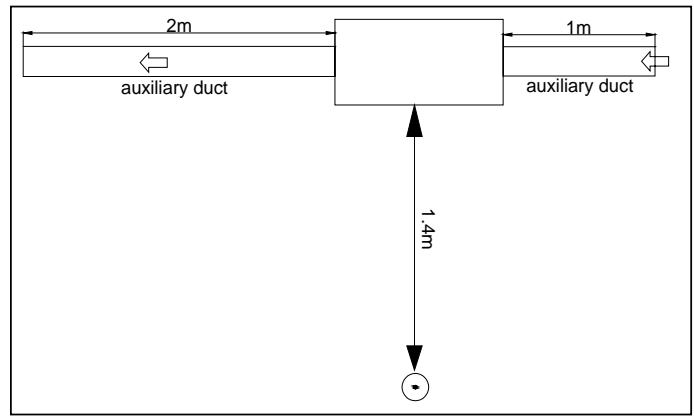

outdoor unit:

1.air outlet from side: the noise level is the average sound pressure level measured from front, left, right directions.

2.air outlet from top: the noise level is the average sound pressure level measured from front, back, left, right directions.

measured point:

$$H \text{ ( height to the ground )} = (h \text{ (unit height) } + 1m) / 2$$

and, it is 1m to each side.

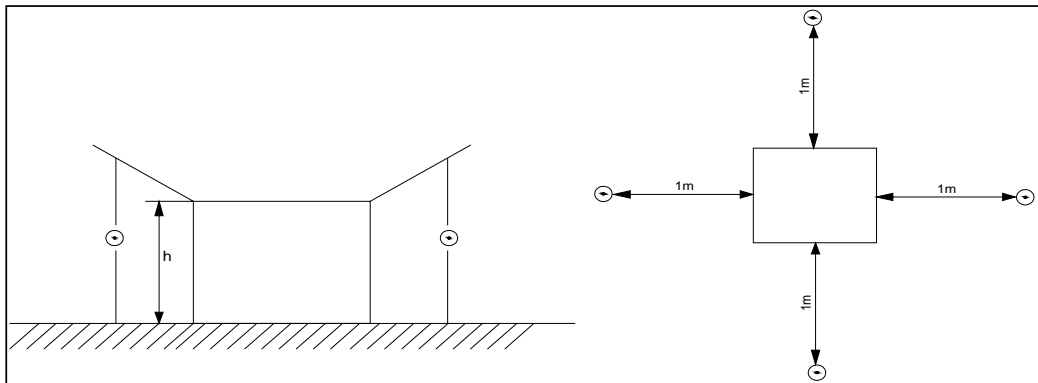

Note: ⊙ is the real time analyser position

### 3. Safety precaution of indoor and outdoor

**Carefully read the following information in order to operate the airconditioner correctly.**

Below are listed three kinds of Safety Cautions and Suggestions.

**WARNING!** Incorrect operations may result in severe consequences of death or serious injuries.

**CAUTION!** Incorrect operations may result in injuries or machine damages; in some cases may cause serious consequences.

**INSTRUCTIONS:** These information can ensure the correct operation of the machine.

Be sure to conform with the following important Safety Cautions.

**The Safety Cautions should be at hand so that they can be checked at any time when needed.**

If the conditioner is transferred to the new user, this manual should be as well transferred to the new user.

## WARNING!

- **If any abnormal phenomena is found (e. g. smell of firing), please cut off the power supply immediately, and contact the dealer to find out the handling method.**

In such case, to continue using the conditioner will damage the conditioner, and may cause electrical shock or fire hazard.

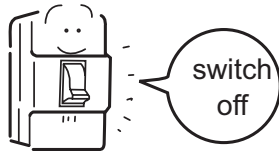

- **After a long time use of air-conditioner the base should be checked for any damages.**

If the damaged base is not repaired, the unit may fall down and cause accidents.



- **Don't dismantle the outlet of the outdoor unit.**

The exposure of fan is very dangerous which may harm human beings.



- **When need maintenance and repairment, call dealer to handle it.**

Incorrect maintenance and repairment may cause water leak, electrical shock and fire hazard.

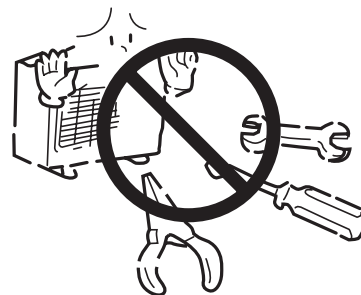

## WARNING!

- **Installed electrical-leaking circuit breaker.**

It easily cause electrical shock without circuit breaker.

- **Air-conditioner can't be installed in the environment with inflammable gases because the inflammable gases near to air-conditioner may cause fire hazard.**

- **Please let the dealer be responsible for installing the conditioner.**

Incorrect installation may cause water leak, electrical shock and fire hazard.

- **Call the dealer to take measures to prevent the refrigerant from leaking.**

If conditioner is installed in a small room be sure to take every measure in order to prevent suffocation accident even in case of refrigerant leakage.

- **When conditioner is deinstalled or reinstalled dealer should be responsible for them.**

Incorrect installation may cause water leaking, electrical shock and fire hazard.

- **Connect earthing wire.**

Earthing wire should not be connected to the gas pipe, water pipe, lightning rod or phone line, in-correct earthing may cause shock.



Earthing

- **No goods or nobody is permitted to placed on or stand on outdoor unit.**

The falling of goods and people may cause accidents.



- **Don't operate the air-conditioner with damp hands.**

Otherwise will be shocked.



- **Only use correctly-typed fuse.**

May not use wire or any other materials replacing fuse, other-wise may cause faults or fire accidents.



- **Use discharge pipe correctly to ensure efficient discharge.**

Incorrect pipe use may cause water leaking.

### 4. Net dimension of indoor and outdoor

HBU-18CF03

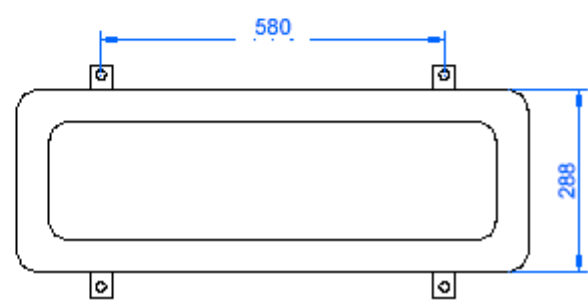
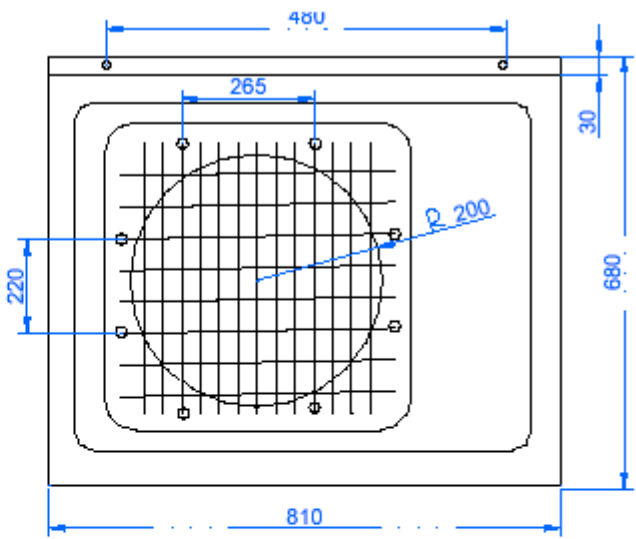
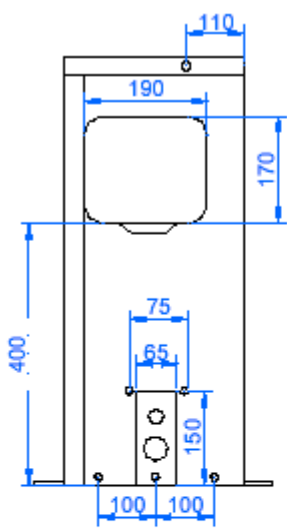
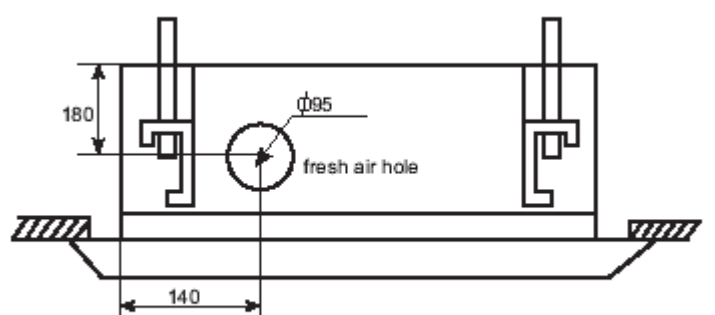
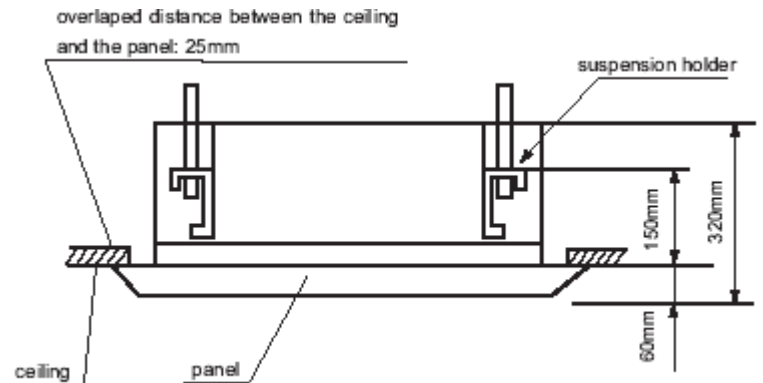
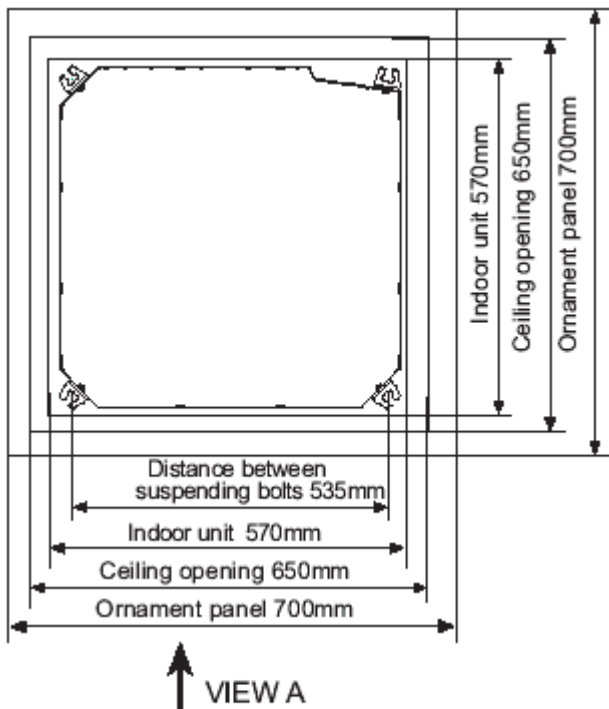

### HDU-42CF03/H

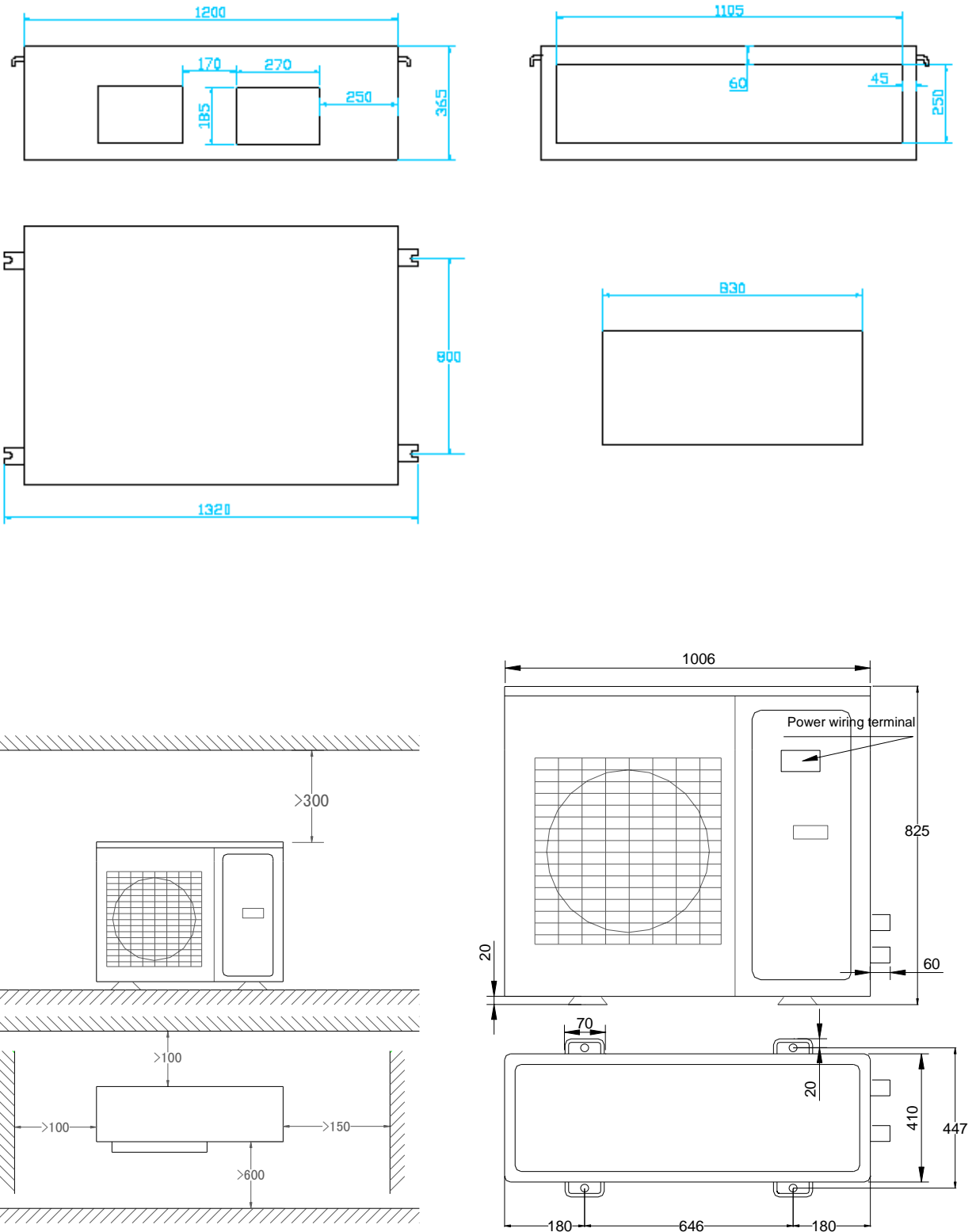

### HPU-42HF03

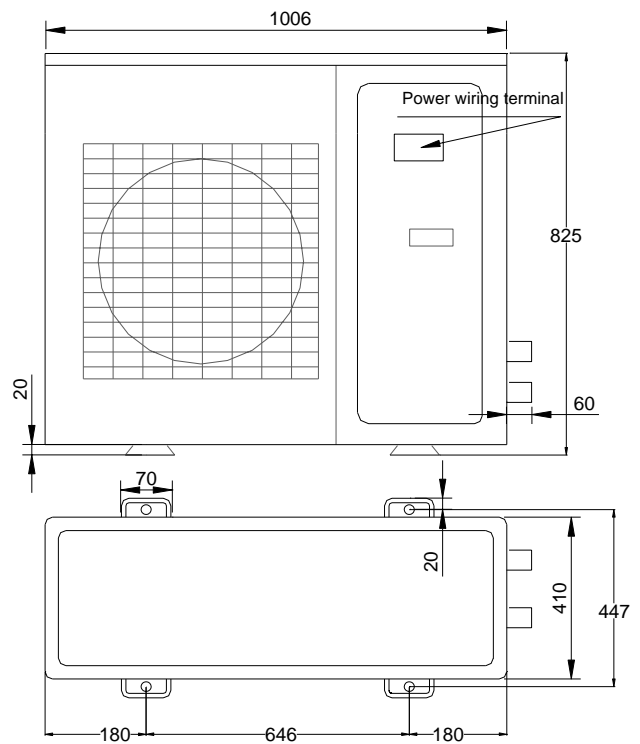
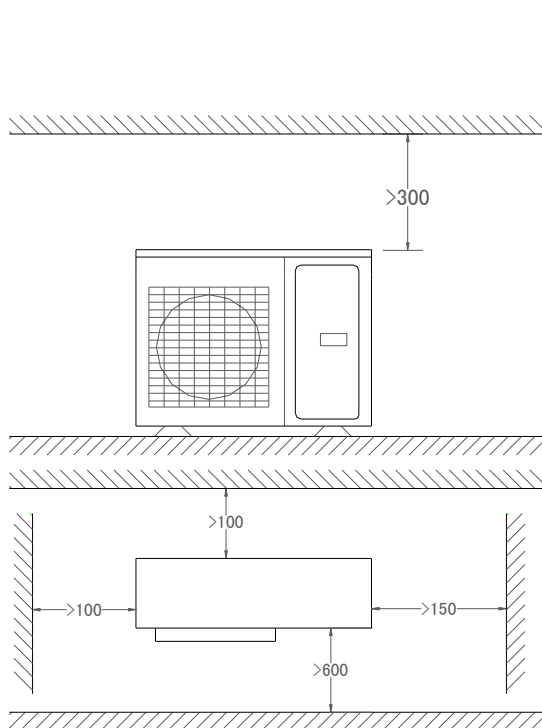
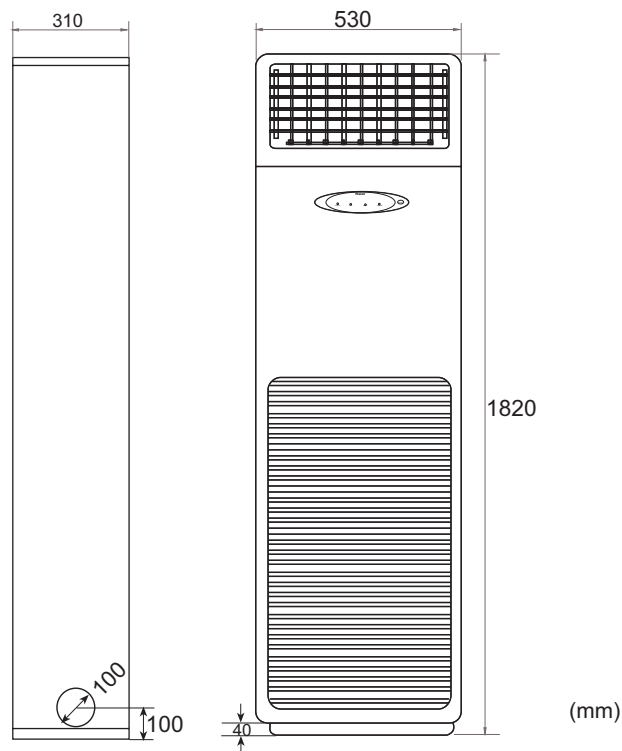

### 5. Installation instructions

#### 5.1 Outdoor unit

"Edging" for protection of electric wires from an opening edge.

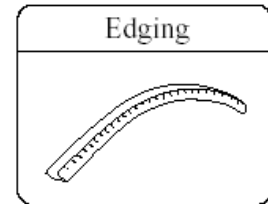

#### Selection of the place of installation

Select the place of installation satisfying the following conditions and, at the same time, obtain a consent from the client or user.

- ▶ Place where air circulates.
- ▶ Place free from heat radiation from other heat sources.
- ▶ Place where drain water may be discharged.
- ▶ Place where noise and hot air may not disturb the neighborhood.
- ▶ Place where there is not heavy snowfall in the winter time.
- ▶ Place where obstacles do not exist near the air inlet and air outlet .
- ▶ Place where the air outlet may not be exposed to a strong wind.
- ▶ Place surrounded at four sides are not suitable for installation. A 1m or more of overhead space is needed for the unit.
- ▶ Mount guide-louvers to place where short-circuit is a possibility.
- ▶ When installing several units, secure sufficient suction space to avoid short circuiting.

#### (1) Open space requirement around the unit

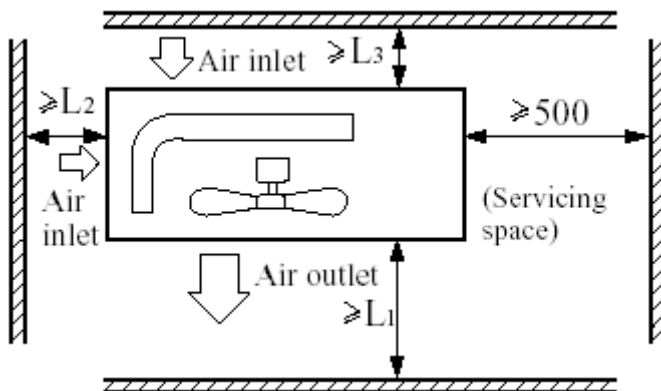

Note :

- (1). Fix the parts with screws
- (2). Don't intake the strong wind directly to outlet air-flow hole.
- (3). A one meter distance should be kept from the unit top
- (4). Don't block the surroundings of the unit with sundries

Unit: mm

| Case     | I    | II   | III  |
|----------|------|------|------|
| Distance |      |      |      |
| L1       | open | open | 500  |
| L2       | 300  | 0    | open |
| L3       | 150  | 300  | 150  |

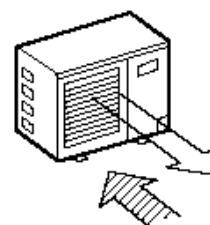

Wind direction



### (2) Installation where the area with strong winds.

Install the unit so that the air outlet section of the unit must NOT be faced toward wind direction.

#### Installation

Fix the unit in a proper way according to the condition of a place where it is installed by referring to the following .

#### (1) Installation

##### (a) Concrete foundation

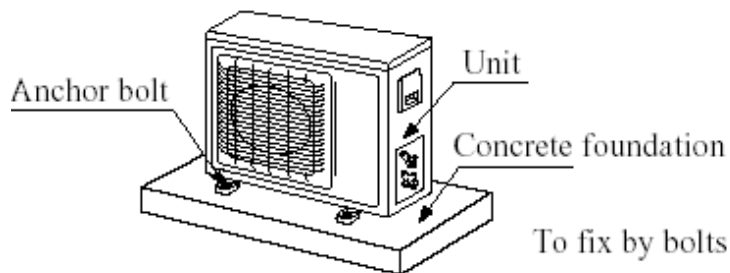

Note: Give enough room for the concrete foundation to fix by anchor bolts.

##### (b) Foundation anchor

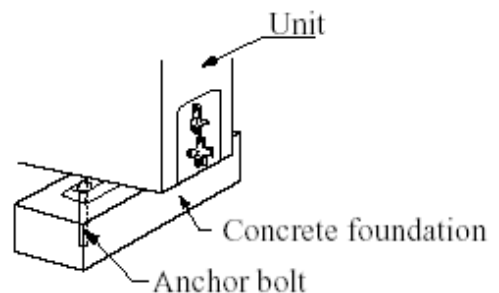

Note: Place the concrete foundation deep enough.

⊕ Install the unit so that the angle of inclination must be less than 3 degrees.

#### (2) Installation sketch of outdoor unit

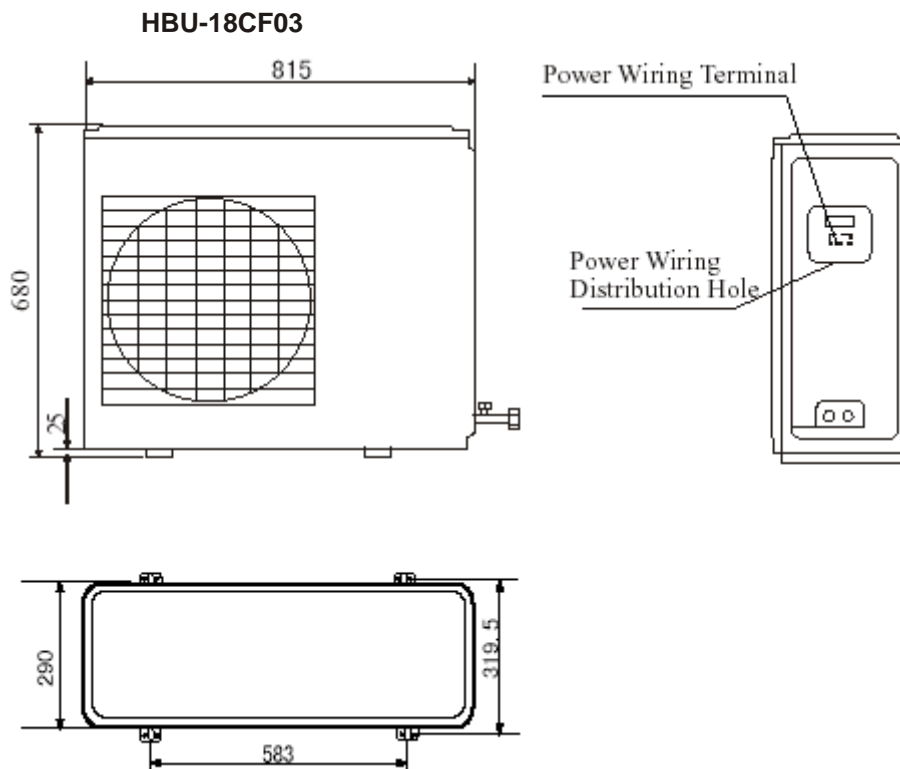

### HDU-42CF03/H HPU-42HF03

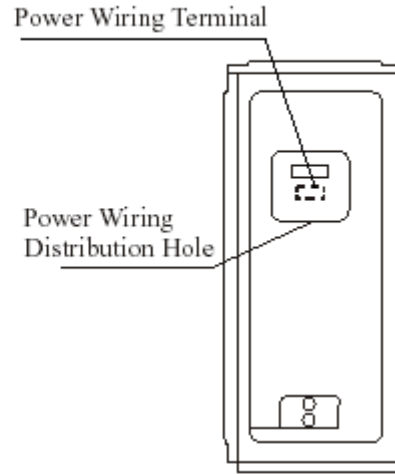
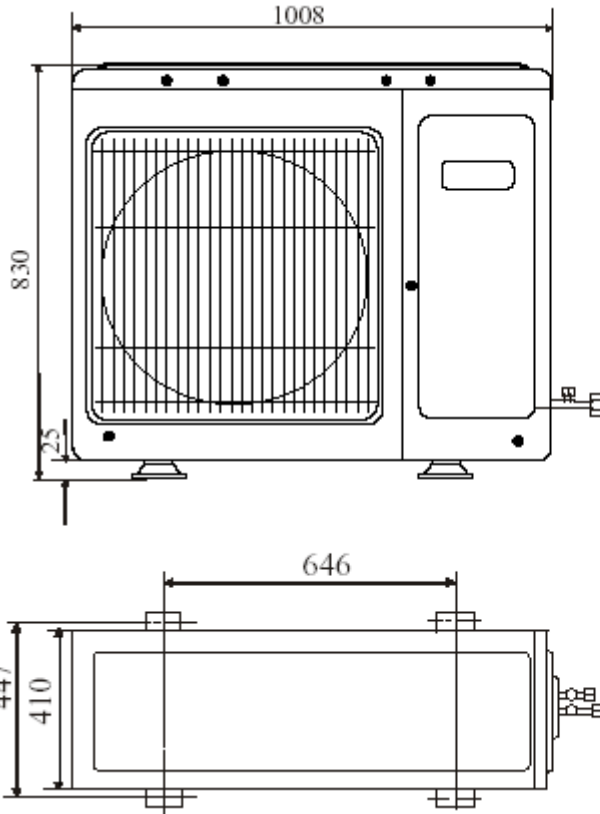

## Refrigerant piping

### (1) Outline piping

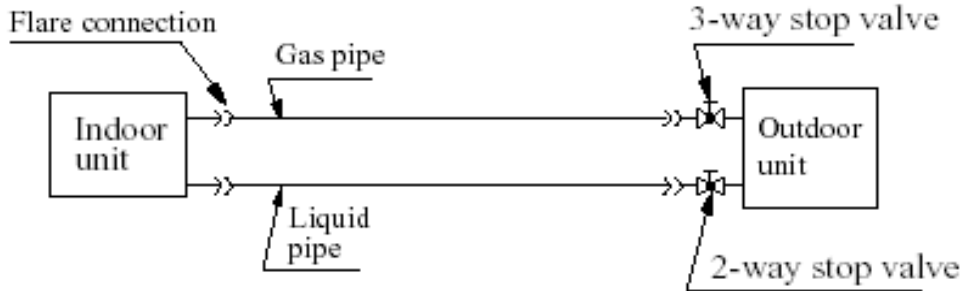

### (2) Piping size

|              |             |               |
|--------------|-------------|---------------|
| HBU-18CF03   | Liquid pipe | Φ 6.35x0.8mm  |
|              | Gas pipe    | Φ 12.7x1.0mm  |
| HDU-42CF03/H | Liquid pipe | Φ 9.52x0.8mm  |
|              | Gas pipe    | Φ 19.05x1.0mm |
| HPU-42HF03   | Liquid pipe | Φ 9.52x0.8mm  |
|              | Gas pipe    | Φ 15.88x1.0mm |

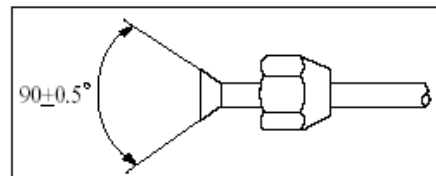

- Install the removed flare nuts to the pipes to be connected, then flare the pipes.

### Precautions for refrigerant piping

- Do not twist or crush piping.
- Be sure that no dust is mixed in piping.
- Bend piping with as wide angle as possible.
- Keep insulating both gas and liquid piping.
- Check flare-connected area for gas leakage.

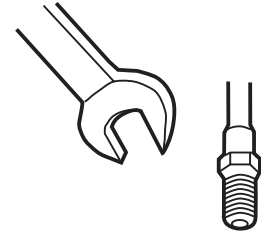

### Piping connection

- Connecting method (indoor unit)  
Apply refrigerant oil at half union as large and flare nut.  
To bend a pipe, give the roundness as possible not to crush the pipe.  
When connecting pipe, hold the pipe centre to centre then screw nut on by hand, refer to Fig.  
Be careful not to let foreign matters, such as sands enter the pipe.



Forced fastening without centering may damage the threads and cause a gas leakage.

| Pipe diameter      | Fastening torque |
|--------------------|------------------|
| Liquid pipe 6.35mm | 14.2-17.2N·m     |
| Liquid pipe 9.52mm | 32.7-39.9N·m     |
| Gas pipe 12.7mm    | 49.5-60.3N·m     |
| Gas pipe 15.88mm   | 61.8-75.4N·m     |
| Gas pipe 19.05mm   | 97.2-118.6N·m    |

### Air discharging method

After finishing connection of refrigerant pipe, it shall perform air tightness test.

- The air tightness test adopts nitrogen tank to give pressure according to the pipe connection mode as the following figure shown.  
The gas and liquid valve are all in close state. In order to prevent the nitrogen entering the circulation system of outdoor unit, tighten the valve rod before giving pressure (both gas and liquid valve rods).

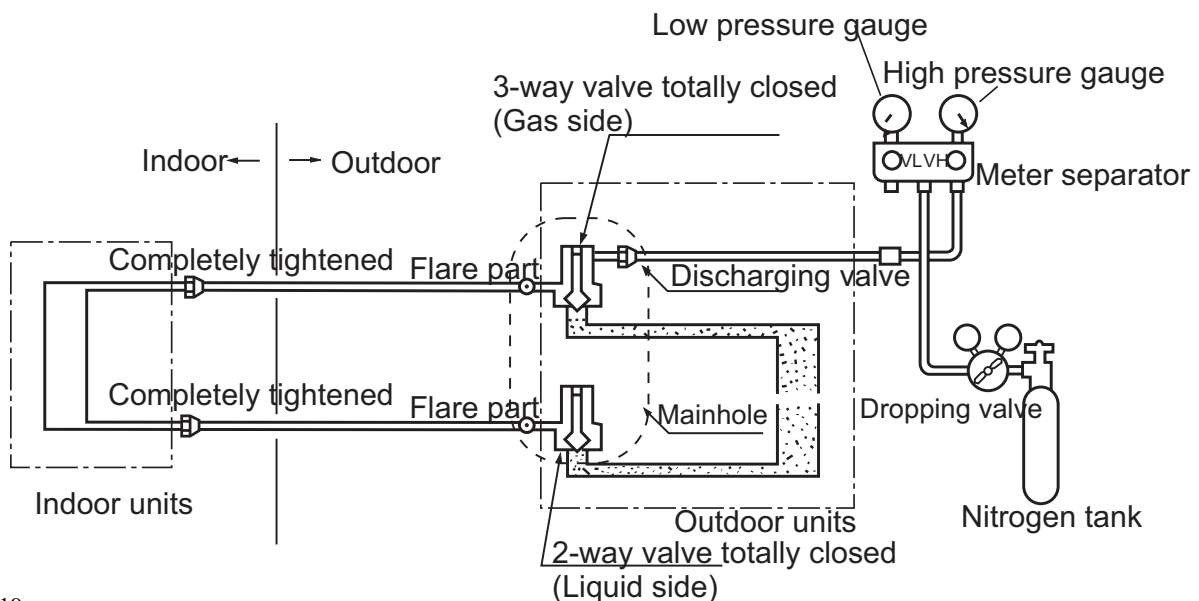

First step: 0.3MPa (3.0kg/cm<sup>2</sup>g) pressurize over 3 minutes.

Second step: 1.5Mpa (15kg/cm<sup>2</sup>g) pressurize over 3 minutes. Large leakage will be found.

Third step: 3.0 MPa (30kg/cm<sup>2</sup>g) pressurize about 24 hours. Little leakage will be found.

- Check if the pressure drops  
If the pressure does not drop, the unit is passed  
If the pressure drops, please check the leaking point.

After pressurizing for 24 hours, each 1°C difference of ambient temperature will result in 0.01MPa(0.1kg/cm<sup>2</sup>g) pressure change. It shall be corrected during test.

- Checking the leaking point  
From the first to third steps, if the pressure drops, check the leakage in each joint by the sense of hearing, feeling or soap water, etc. to find the leaking point.  
After confirming the leaking point, welding it again or tighten the nut tightly again.

#### Piping and indoor unit vacuumizing

- Use vacuum pump to perform vacuumizing. It is strictly forbidden to use the refrigerant to remove the air inside the system.
- After air tightness test and discharging all the nitrogen, connect the vacuum pump as the following figure shown.

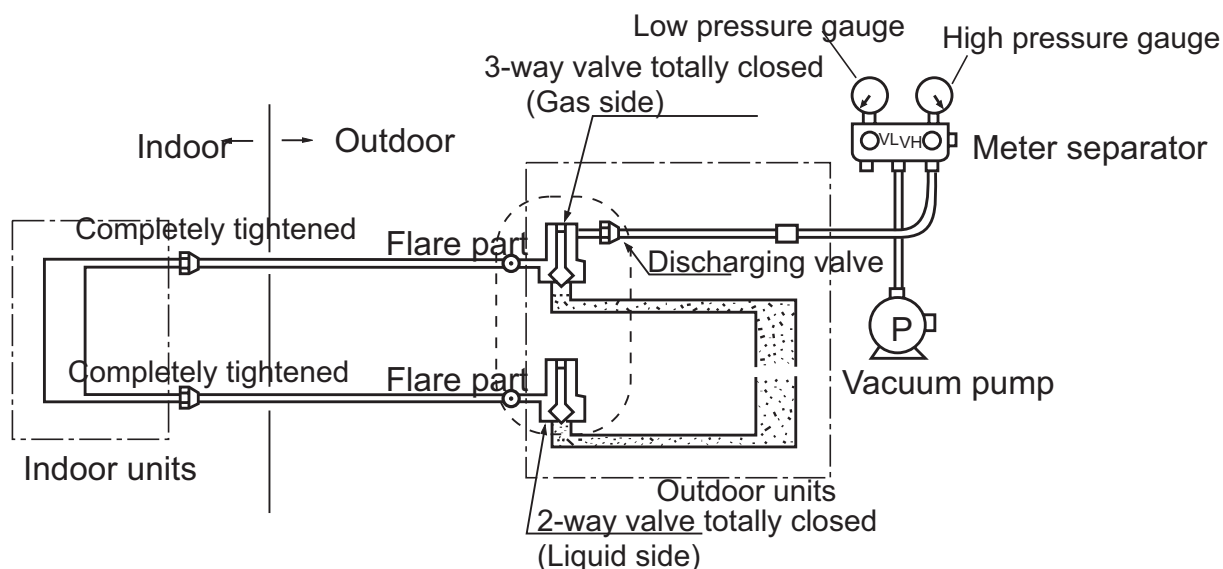

- It shall use the vacuum pump of (lower than -755mmHg)high vacuum degree and large air discharging (over 40l/min).
- The vacuumizing time depends on the length of the connecting pipe, generally is 1~2 hours. When vacuumizing, it shall be confirmed both gas and liquid side valves are closed.
- If after 2 hours vacuumizing, it cannot reach the vacuum degree below -755mmHg, it can be vacuumized for other 1 hour.
- If after 3 hours vacuumizing, it still cannot reach the vacuum degree below -755mmHg, check if there is any leaking point and repair the them.

- If after over 2 hours vacuumizing, the vacuum degree is below -755mmHg, close the VL and VH on the meter separator and stop vacuumizing. 1 hour later to confirm if the vacuum degree changes. If changes, it indicates there is leaking point in the system. Check the leaking point and repair.
- After finishing the above vacuumizing, change the vacuum pump into refrigerant pump to charge the refrigerant.

### Charging amount of refrigerant

When the total length (L) of the two indoor units' connecting pipe is less than 5m, it is unnecessary to charge additional refrigerant.

If the connecting pipe (L) exceeds 5m, it shall charge Mg additional refrigerant per meter.

That is: Refrigerant charging amount = (L-5) x M (g)

For the unit with liquid pipe 6.35mm, M=30

For the unit with liquid pipe 9.52mm, M=65

Only in COOLING operation can charge the additional refrigerant.

- When charging, the refrigerant shall be charged from the charging nozzle of low pressure vavle.
- Be carefull when charging refrigerant, do not let the air mix into the system, and must charge the additional refrigerant in liquid condition.

### Electric wiring

**⚠ WARNING**

**DANGER OF BODILY INJURY OR DEATH**

TURN OFF ELECTRIC POWER AT CIRCUIT BREAKER OR POWER SOURCE BEFORE MAKING ANY ELECTRIC CONNECTIONS.

GROUND CONNECTIONS MUST BE COMPLETED BEFORE MAKING LINE VOLTAGE CONNECTIONS.

#### (1) Selection of size of power supply and interconnecting wires.

##### Precautions for Electric wiring

Electric wiring work should be conducted only by authorized personnel.

Do not connect more than three wires to the terminal block. Always use round type crimped terminal lugs with insulated grip on the ends of the wires.

Use copper conductor only.

Select wire sizes and circuit protection from table below. (This table shows 20 m length wires with less than 2% voltage drop.)

| Item<br>Model | Phase | Circuit breaker       |   | Power source<br>wire size<br>(minimum) | Earth leakage breaker |                 |
|---------------|-------|-----------------------|---|--|-----------------------|-----------------|
|               |       | Switch breaker<br>(A) | Overcurrent protector<br>rated capacity (A) |  | Switch<br>breaker     | Leak<br>current |
| HBU-18CF03    | 1     | 30                    | 20  | 2.5mm <sup>2</sup>                     | 30                    | 30mA            |
| HDU-42CF03/H  | 3     | 30                    | 20  | 2.5mm <sup>2</sup>                     | 30                    | 30mA            |
|               |       |                       |   |  |                       |                 |

### (2) Wiring connection

Make wiring to supply power to the outdoor unit, so that the power for the indoor unit is supplied by terminals.

**For the detailed wiring connection with the indoor units, see the corresponding indoor operation and instruction manual.**

#### HBU-18CF03

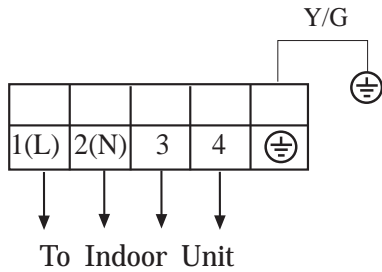

#### HDU-42CF03/H

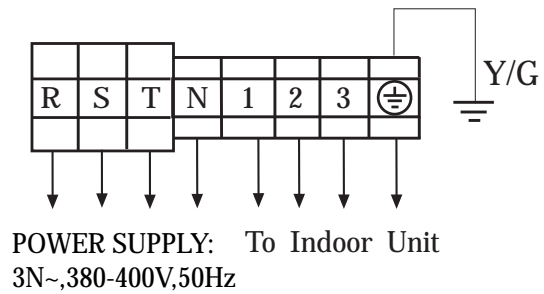

#### HPU-42HF03

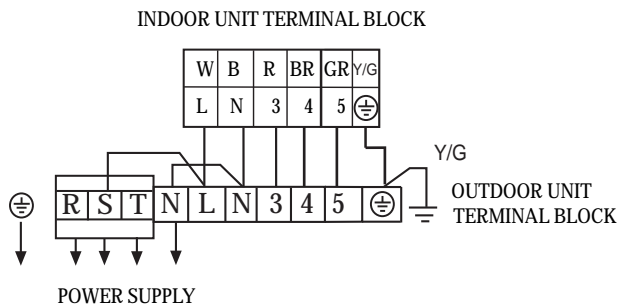

### (3) Wiring procedure

- 1) Remove set screws on the side before taking off the front panel toward the direction shown in figure.
- 2) Connect wires to the terminal block correctly and fix the wires with a wire clamp equipped nearby the terminal block.
- 3) Route the wires in a proper way and penetrate the wires through the opening for electric wiring on the side panel.

### 5.2 Indoor unit installation

#### 5.2.1 Cassette indoor unit(HBU-18CF03)

#### Installation Tools

Installation tools

The installation tools listed in the following sheet can be used as required.

1. Screw driver
2. Hacksaw
3. Drill with a diameter of 60mm
4. Inner hexagon spanner, shifting spanner
5. Spanner (14, 17, 19,24,27mm)
6. Pipe cutter
7. Pipe expander
8. Knife
9. Pincers
10. Leakage detector or soapy water
11. Band tape
12. Scraper
13. Refrigerant oil

The following parts mentioned in this manual are the installation accessories we prepared.

| Symbol | Parts Name                               |
|--------|--|
| A      | Adhesive tape                            |
| B      | Pipe clamp                               |
| C      | Connecting hose                          |
| D      | Drainage hose                            |
| E      | Non-hydroscopic heat insulating material |
| F      | Gypsum powder                            |

#### Installation Procedures

Selection of Installation Place

- (1) Place above the ceiling where it is enough space to arrange the unit.
- (2) Place where the drainage pipe can be arranged well.
- (3) Place where inlet and outlet air of indoor and outdoor unit will not be blocked.
- (4) Do not expose the unit to the place with heavy oil or moisture (e.g.kitchen and workshop).
- (5) Do not set the unit in the place where destructive gas (such as sulfuric acid gas) or pungent gas (thinner and gasoline) concentrates and retains.
- (6) Place strong enough to support the unit .
- (7) No expensive articles such as television and piano below indoor unit.
- (8) Enough space for maintenance.
- (9) Place more than 1m away from television and radio to avoid disturbing television and radio.
- (10) Easy for maintenance.

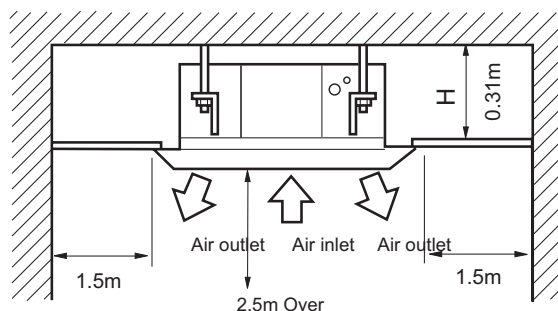

### Installation Preparation

(1) Position of ceiling opening between unit and suspending bolt (front view of unit).

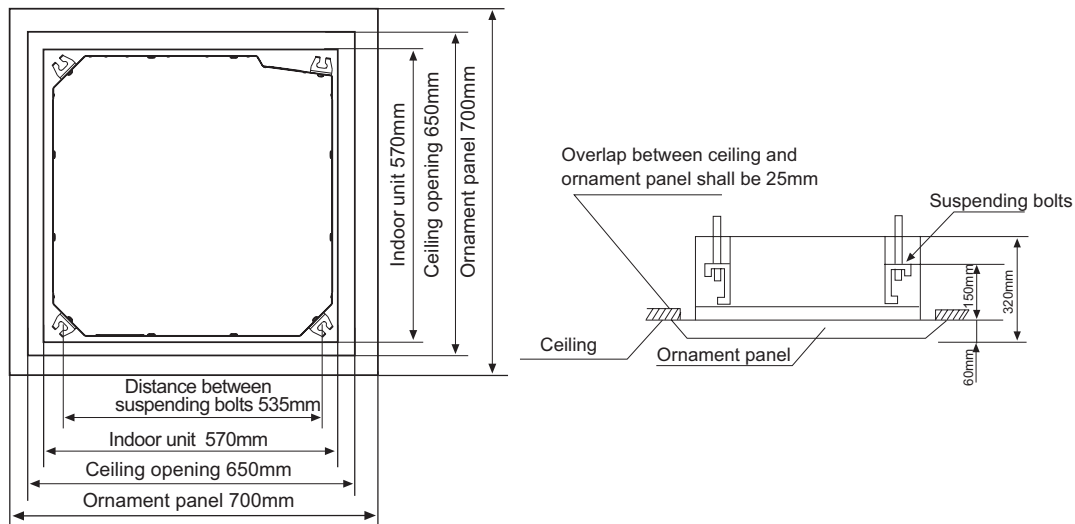

(2) Prepare all piping (refrigerant, water drainage) and wires (connection wire of remote controller, indoor unit connection wires) to the indoor unit before installation in order to connect indoor unit immediately after installation.

(3) Install a suspending bolt

To support the unit weight, anchor bolt should be used in the case of the existing ceiling. For new ceiling, use flush-in type bolt, built-in type bolt or parts prepared in the field.

Before going on installing, adjust the distance to ceiling.

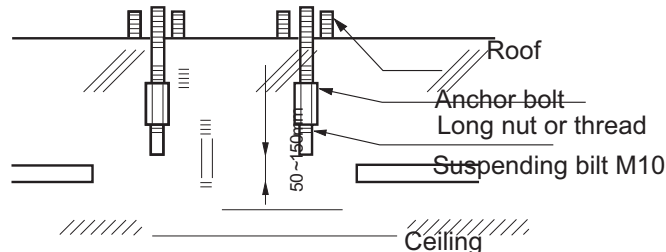

<Installation Example>

Note: All the above mentioned parts shall be prepared in field, the diameter of suspending bolt is M10

### Installation of indoor unit

In case of no ceiling

Install unit temporarily

Put suspending bracket on the suspending bolt to hang the unit up. Be sure to use nut and washer at both end of the bracket to secure firmly.

After installation on the ceiling

(1) Adjust unit to its right position (Refer to preparation for installation-(1))

(2) Check that unit is horizontal.

Water pump and floating switch is installed inside indoor unit, check four corners of the unit for its level using horizontal comparator or PVC tube with water. (If unit is tilting against the direction of water drainage, problem may occur on floating water leakage.)



### In the case of existing ceiling

#### (1) Install unit temporarily

Put suspending bracket on the suspending bolt to hang the unit up. Be sure to use nut and washer at both end of the bracket to secure it firmly.

#### (2) Adjust the height and position of the unit.

#### (3) Proceed with procedure (4) of " In the case of no ceiling "

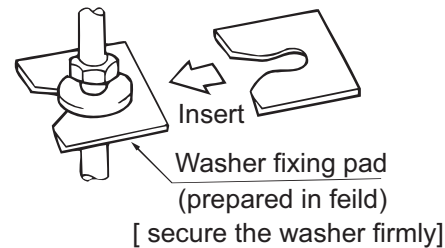
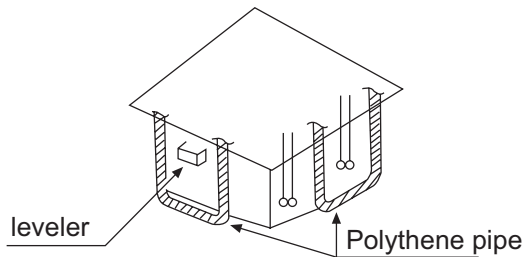
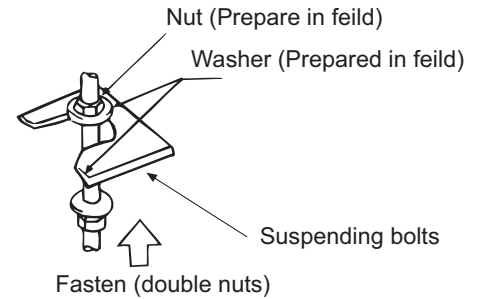

### Installation of water drainage pipe

#### (1) Install water drainage pipe

- Pipe diameter shall be equal or larger than that of connecting pipe (Pipe of polythene; size: 25mm; O.D.: 32mm )
- Drainpipe should be short, with a downward slope at least 1/100 to prevent air bag from forming.
- If downward slope of drainpipe cannot be made, lifting pipe shall be installed.
- Keep a distance of 1-1.5m between suspending bolts, to make water hose straight.

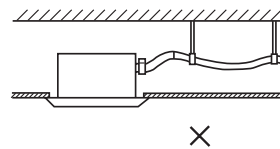
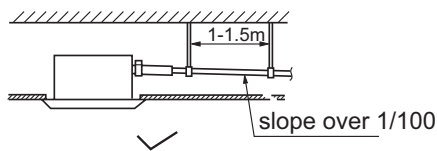

- Use the drainage hose and clip provided with unit.  
Insert water pipe into water plug until it reaches the white tape.  
Tighten the clip until head of the screw is less than 4mm from hose.
- Wind the drainage hose to the clip using seal pad for heat insulation.
- Insulate drainage hose in the room.

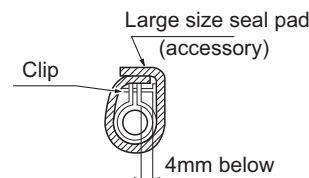
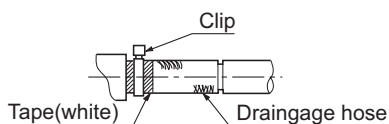

### Cautions for the water drainage lifting pipe

- Installation height of water drainage lifting pipe shall be less than 280mm
- There should be a right angle with unit ,300mm from unit.

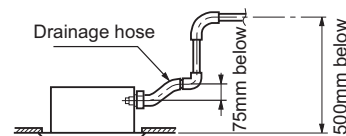
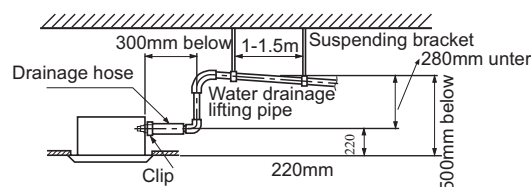

### < Note >

- The slope of water drainage hose shall be within 75mm , make the drainage plug not to bear excessive force.
- If several water hoses join together, of as per following procedures.

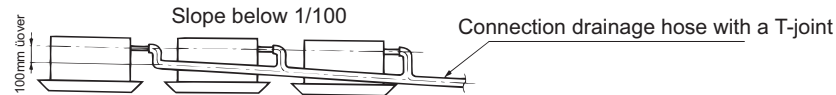

Specifications of the selected drainage hoses shall meet the requirements for the unit running

### Installation of Ornament Panel

Install ornament panel on indoor unit

- (1) Check whether indoor unit is horizontal with leveler or polythene pipe filled with water , and check that the dimension of the ceiling opening is correct. Take off the lever gauge before installing the ornament panel.
- (2) Fasten the screws to make the height difference between the two sides of indoor unit less than 5mm.
- (3) Firstly fix it with screws temporarily.
- (4) Fasten the two temporarily fixing screws and other two, and tighten the four screws.
- (5) Connect the wires of synchro-motor.
- (6) Connect the wire of signal.
- (7) If no response of remote controller,check whether the wiring is correct,restart remote controller 10 seconds after shut off power supply.

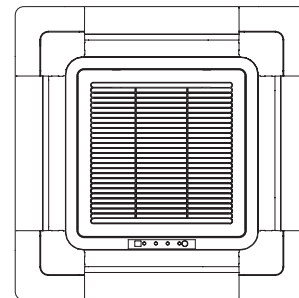
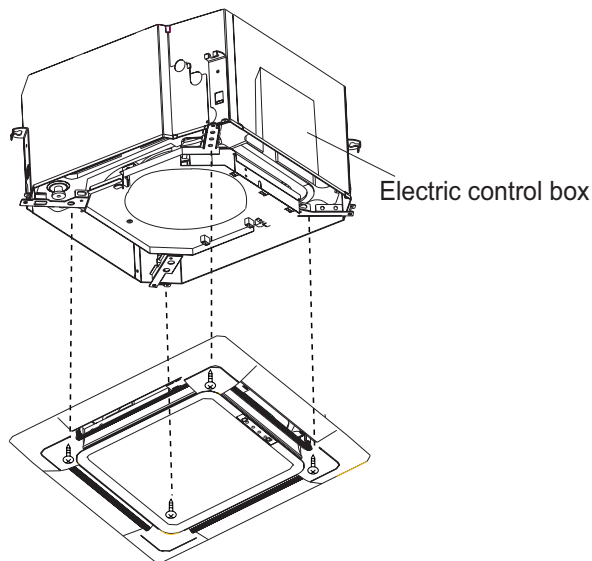

### Panel limitation board installation

- (1) Install the panel board in the direction shown in the figure.
- (2) The incorrect direction will result in water leakage, meanwhile swing and signal receiving are displayed that cannot be connected.

#### Piping Connection

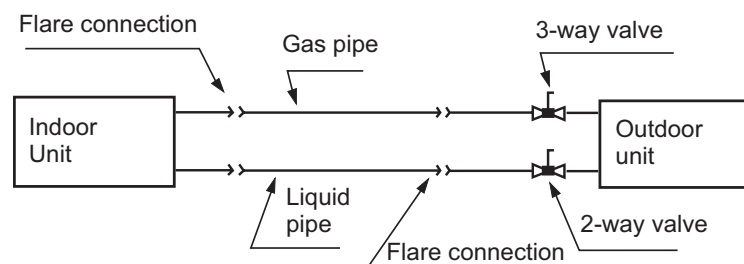

### 5.2.2 Duct indoor unit(HDU-42CF03/H)

#### 5.2.2.1 Preparation before installation

##### (1) The position relation among hoisting screw (unit: mm)

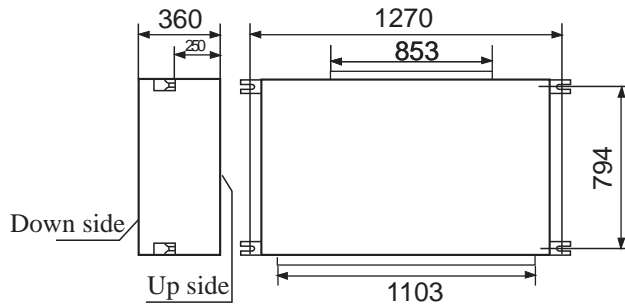

##### (2) If necessary, cut the opening installation and checking needed on the ceiling. (If has ceiling)

- Before installation, finish the preparation work of all the pipes (refrigerant, drainage) and wire (wire controller connection wire, indoor and outdoor unit connection wire) of indoor unit, so that after installation, they can be immediately connected with outdoor unit.
- Cut the opening on the ceiling. Maybe it needs to strengthen the ceiling to keep the ceiling even and flat and prevent the ceiling from vibration. For details, please consult to the builder.

##### (3) Hanger bolts installation

- Use care of the piping direction when the unit is installed.

(Use M10 screw bolt)

In order to bear the weight of the unit, for existed ceiling, using foundation screw bolt, for new ceiling, using burying embedded screw bolt, burying screw bolt or spot supplied other parts.

Before going on installation, adjust the gaps with ceiling.

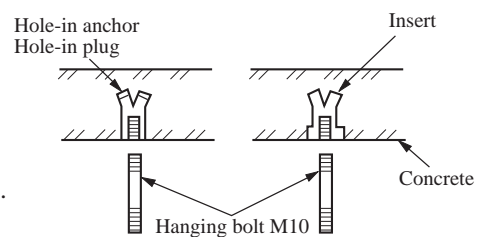

### 5.2.2.2 Installation of indoor unit

- Fix the indoor unit to the hanger bolts.  
If required, it is possible to suspend the unit to the beam, etc.  
Directly by use of the bolts without using the hanger bolts.

**Note**

When the dimensions of main unit and ceiling holes does not match, it can be adjusted with the slot holes of hanging bracket.

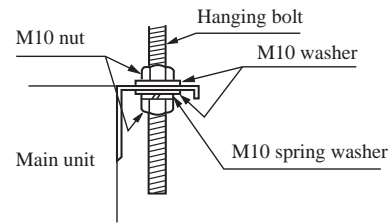

**Adjusting to the levelness**

- Adjust the out-of levelness using a level or by the following method.
  - Make adjustment so that the relation between the lower surface of the unit proper and water level in the hose becomes as given below.

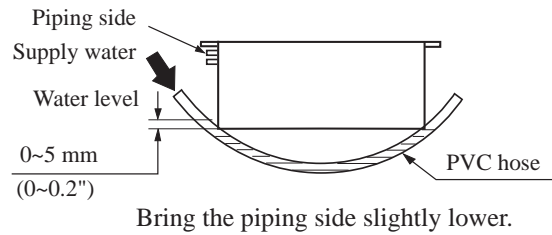

- Unless the adjustment to the levelness is made properly, malfunctioning or failure of the float switch may occur.

### 5.2.2.3 Drain Piping

- Drain piping should always be in a downhill grade (1/50~1/100) and avoid riding across an elevation or making traps.

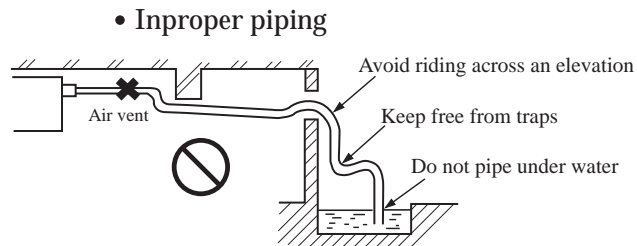
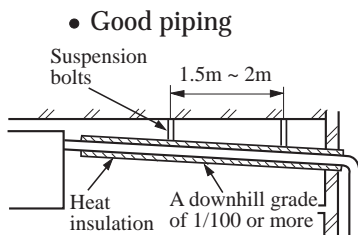

- When connecting the drain pipe to unit, pay sufficient attention not to apply excess force to the piping on the unit side. Also, fix the piping at a point as close as possible to the unit.

- For drain pipe, use hard PVC general purpose pipe VP-25(I.D.1") which can be purchased locally. When connecting, insert a PVC pipe end securely into the drain socket before tightening securely using the attached drain hose and clamp. Adhesive must not be used connection of the drain socket and drain hose (accessory).

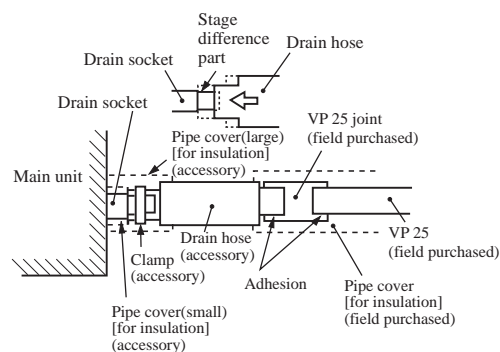

- (d) When constructing drain piping for several units, position the common pipe about 100 mm below the drain outlet of each unit as shown in the sketch. Use VP-30(1 1/4") or thicker pipe for this purpose.

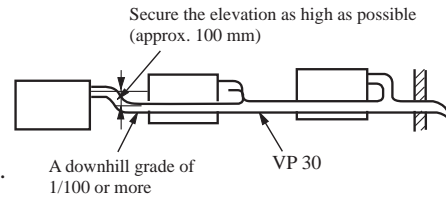

- (e) The stiff PVC pipe put indoor side should be heat insulated.
- (f) Avoid putting the outlet of drain hose in the places with irritant gas generated. Do not insert the drain hose directly into drainage, where the gas with sulfur may be generated.
- (g) Backwater bend

Because the drain spout is at the position, which negative pressure may occur. So with the rise of water level in the drain pan, water leakage may occur. In order to prevent water leakage, we designed a backwater bend.

The structure of backwater bend should be able to be cleaned. As the below figure shown, use T type joint. The backwater bend is set near the air conditioner.

- As figure shown, set a backwater bend in the middle of drain hose.

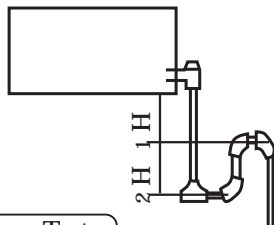

$H1=100\text{mm}$  or the static pressure of air sending motor  
 $H2=1/2H1$  (or between 50~100mm)

### Drainage Test

- Conduct a drainage test after completion of the electrical work.
- During the trial, make sure that drain flows properly through the piping and that no water leaks from connections.
- In case of a new building, conduct the test before it is furnished with the ceiling.
- Be sure to conduct this test even when the unit is installed in the heating season.

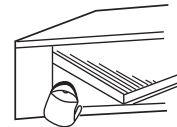

### Procedures

- Supply about 1000 cc of water to the unit through the air outlet using a feed water pump.
- Check the drain while cooling operation.

### 5.2.2.4 Installation of air suction and discharging duct

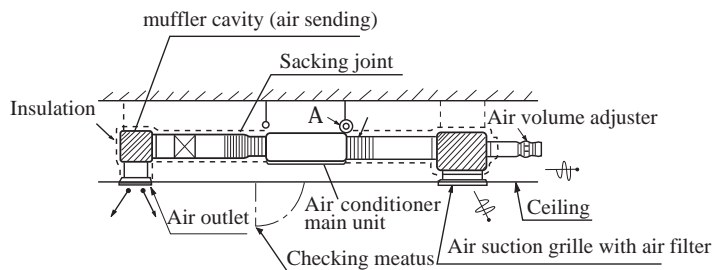

Enlarging chart of profile chart A  
Vibration resistance hook

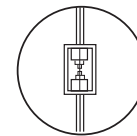

Please consult the after-sales service worker of Haier Air Conditioner for the choosing and installation of suction inlet, suction duct, discharging outlet and discharging duct. Calculating the design drawing and outer static pressure, and choose the discharging duct with proper length and shape.

- The length difference among every duct is limited below 2:1.
- Reduce the length of duct as possible as can.
- Reduce the amount of bend as possible as can.
- Use heat insulation material to bind and seal the part connecting main unit and the flare part of air discharging duct. Perform duct installation work, before the fitment of ceiling.

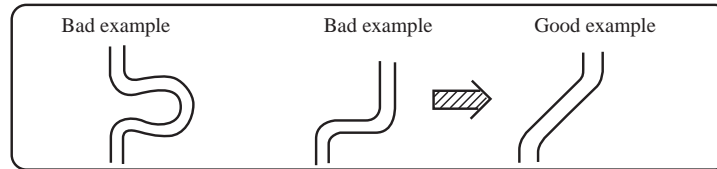

### 5.2.2.5 Calculation method of the dimension of the simple quadrate air duct

Presuming the unit length friction impedance of the duct is 1Pa/m, when the dimension of one side of the air duct is fixed as 250mm, as shown below:

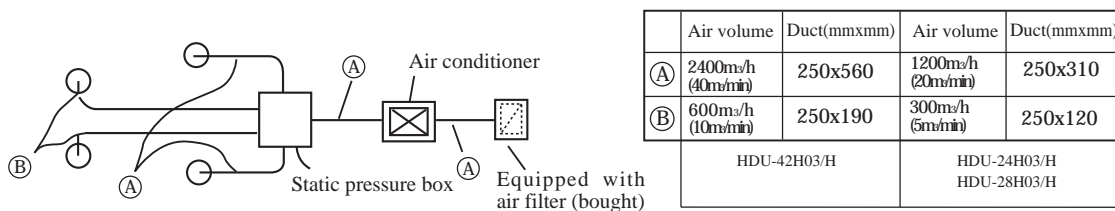

- The calculation of duct resistance (the simple calculation is as follow table)

|                                    |   |
|------------------------------------|---|
| Straight part                      | Calculate as per 1m length 1Pa, 1Pa/m       |
| Bend part                          | Each bend takes as a3~4m long straight duct |
| Air out part                       | Calculate as 25Pa                           |
| Static pressure box                | Calculate as 50Pa/each                      |
| Air inlet grille (with air filter) | Calculate as 40Pa/each                      |

- The chosen chart of simple duct

Note: 1Pa/m=0.1mmAg/m

| Shape                                | Square duct |
|--------------------------------------|-------------|
| Item                                 | Dimension   |
| Air volume                           | Dimension   |
| m <sup>3</sup> /h(m <sup>3</sup> /n) | (mmxmm)     |
| 100                                  | 250 x 60    |
| 200                                  | 250 x 90    |
| 300                                  | 250 x 120   |
| 400                                  | 250 x 140   |
| 500                                  | 250 x 170   |
| 600(10)                              | 250 x 190   |
| 800                                  | 250 x 230   |
| 1,000                                | 250 x 270   |
| 1,200(20)                            | 250 x 310   |
| 1,400                                | 250 x 350   |
| 1,600                                | 250 x 390   |

| Shape                                | Square duct |
|--------------------------------------|-------------|
| Item                                 | Dimension   |
| Air volume                           | Dimension   |
| m <sup>3</sup> /h(m <sup>3</sup> /n) | (mmxmm)     |
| 1,800(30)                            | 250 x 430   |
| 2000                                 | 250 x 470   |
| 2400                                 | 250 x 560   |
| 3,000(50)                            | 250 x 650   |
| 3,500                                | 250 x 740   |
| 4,000                                | 250 x 830   |
| 4,500                                | 250 x 920   |
| 5,000                                | 250 x 1000  |
| 5,500                                | 250 x 1090  |
| 6,000(100)                           | 250 x 1180  |

### 5.2.2.6 The attentive matters in installation of air suction and discharging duct

- Recommend to use anti-frost and sound-absorbing duct. (locally bought)
- The duct installation work should be finished before the fitment of ceiling.
- The duct must be heat insulated.
- The specific air-discharging outlet should be installed at the place where the airflow can be reasonably distributed.
- The surface should leave a checking meatus for checking and maintenance.

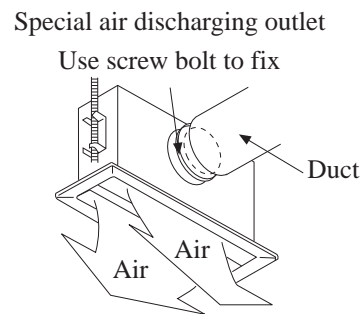

### 5.2.2.7 The examples of improper installation

- Do not use air in duct and take the ceiling inner side instead. The result is because of the irregular outer air mass, strong wind and sunshine, the humidity is increased.
- There may be water drop on the outside of duct. For cement and other new constructions, even if not taking ceiling inner side as duct, the humidity will also be so high. At this time, use glass fiber to perform heat preservation to the whole. (use iron net to bind the glass fiber)
- Maybe exceeding the unit operation limit (for example: when indoor dry bulb temperature is 35 °C, wet bulb temperature 24 °C), it may lead to overload of compressor.
- Affected by the capacity of air discharging fan, the strong wind in the outer duct and wind direction, when unit air sending volume exceeds the limit, the discharged water of heat exchanger will overflow, leading to water leakage.

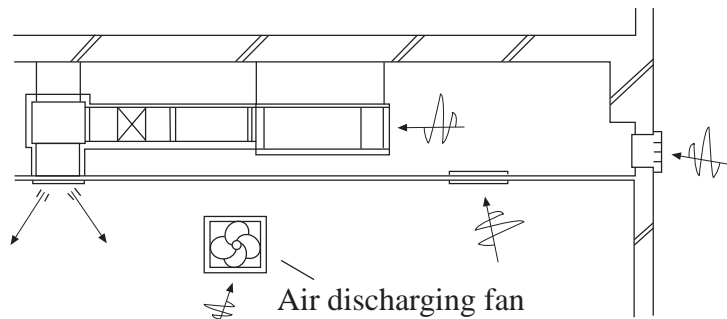

Improper example

### 5.2.3 Cabinet indoor unit(HPU-42HF03)

#### Display of whole unit

- Try to bring the packed unit to the installation place.
- When it is necessary to unpack the unit, be careful not to damage the unit. Wrap it with nylon etc.
- After unpacking, be sure to place the unit with the front side to be up.

Note: When delivering, don't hold plastic parts such as inlet or outlet grill etc.

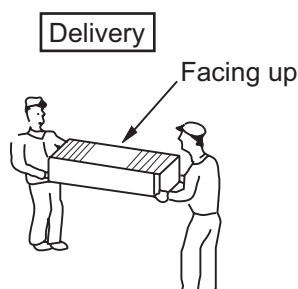

#### Fixing of the unit

##### Position of the wall hole

- Wall hole should be decided according to installation place and piping direction. (refer to installation drawings)

##### Making a hole

- Drill a hole of 70mm dia. with a little slope towards outside.
- Install piping hole cover and seal it with putty after installation.

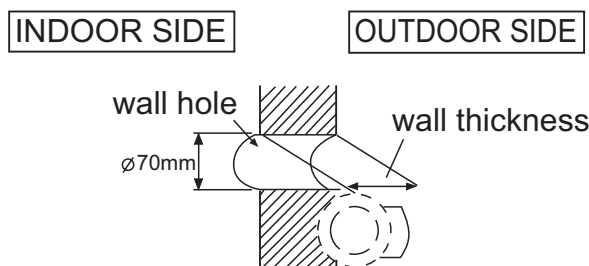

( Cross section of wall hole )

#### Fixing of indoor unit

To prevent it from fall off, please fix the unit with fall-prevention fitting at wall and L-shaped metal at floor.

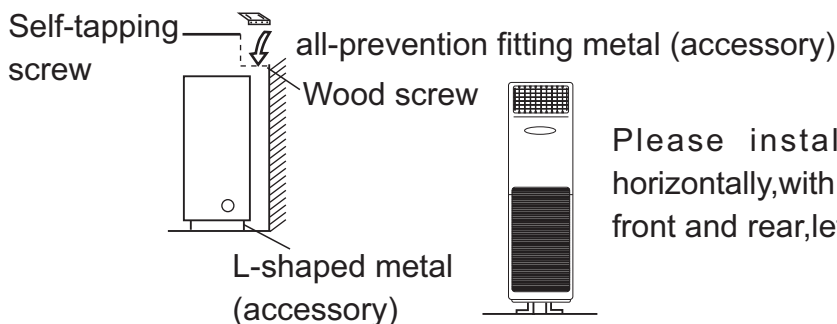

Please install the whole unit horizontally, with a slope of 1 degree at front and rear, left and right.



### Installation of anti-fall plate:

Fix the anti-fall plate to the wall with screws so that there is no clearance between them. With the unit set up vertically, fix the anti-fall plate to the unit with screws while making an adjustment at the long portion of the hole so that there is no clearance between the upper surface and the anti-fall plate.

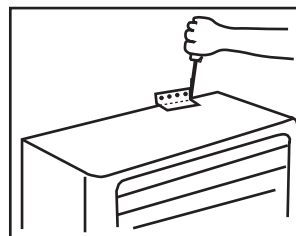
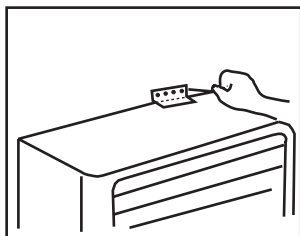

### Installation of L-shaped metal

Fix to the unit with screws so that there is no clearance between the anti-fall plate and the unit. After confirming that the unit has been set up vertically to the floor, fix it to the floor with bolt.

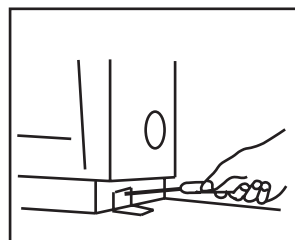
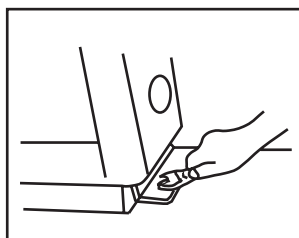

### Piping connection

Connecting method

Apply refrigerant oil at half union and flare nut.

To bend a pipe, give the roundness as large as possible not to crash the pipe.

When connecting pipe, hold the pipe centre to centre then screw nut on by hand, refer to Fig.

Be careful not to let sundries, such as sands enter the pipe.

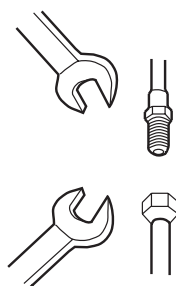

Forced fastening without centering may damage the threads and cause a gas leakage.

| Pipe dia                 | Fastening torque |
|--------------------------|------------------|
| Liquid pipe 9.52mm(3/8") | 29.4N·m          |
| Gas pipe 15.88mm(5/8")   | 98.0N·m          |
| Gas pipe 19.05mm(3/4")   | 117.7N·m         |

### Piping connection of indoor unit

Arrangement of piping and drainage pipe

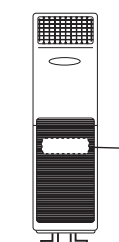

After opening inlet grill, you will see a control box as shown in the Fig.

Remove the cover before wiring work.

Cut away, with a hammer or a saw, the lid for piping according to piping direction.

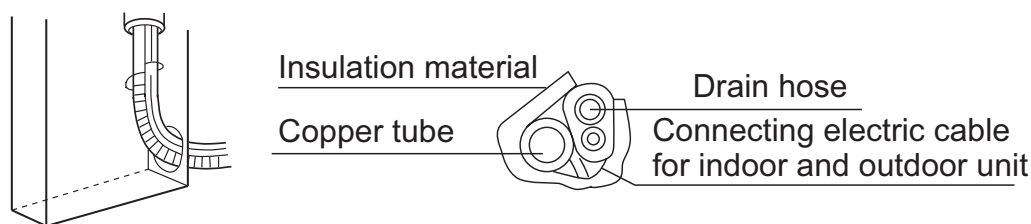

According to the piping method, connect the piping on indoor unit with union of connecting pipe.

Arrange the piping as per the wall hole and bind drain hose connecting electric cable and piping together with polyethylene tape.

Insert the bound piping connecting electric cable and drain hose through wall hole to connect with outdoor unit.

### Arrangement of drain hose

- Drain hose shall be placed in under place.
- There should be a slope when arrange drain hose. Avoid up and down waves in drain hose.

#### Indoor unit

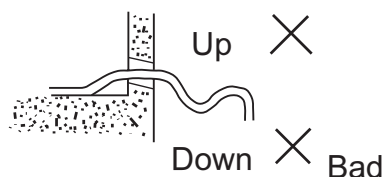
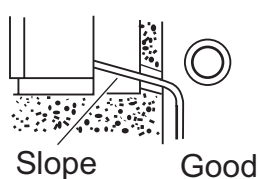

If humidity is high, drain pipe( especially in room and indoor unit ) must be covered with insulation material.

### Piping connection of outdoor unit

Connect the connecting pipe and inlet and outlet liquid pipe according to the piping method.

### Purging method

Discharge the air out of the indoor unit and the refrigerant pipe by vacuumizing

- (1) Fasten all the nuts of the indoor and outdoor pipes to make these parts out of leakage.
- (2) Under the condition of the complete close of the indoor and outdoor valve center (both liquid and gas side),dismount the repair valve cap.Vacuumizing through the charge mouth of the repair valve.
- (3) After vacuumizing fasten the repair valve,and dismount the cap of the big and small stop valve,then loosen the stop valve center completely and fasten the big and small stop valve.

### Extra charging amount of the refrigerant

When piping is longer than 5 m, charge additional refrigerant as per 65g/m.

## Electric wiring

Note:

Electric wiring must be done by qualified person.

Use copper wire only, the parameter of connecting cable is H07RN-F 4G 0.75mm<sup>2</sup>.

The power cable should be over 5G2.5mm<sup>2</sup>, the power cable is self-provided.

The power supply connects from the outdoor unit.

### Wiring of indoor unit

Insert the cable from outside the wall hole where piping already exist.

Pull it out from front.

Loosen terminal screws and insert cable end fully into terminal block, then tighten it.

Pull the cable gently to make sure it is tight.

Replace cover after wiring.

### Wiring of outdoor unit

Insert the cable from inside the wall hole where piping already exists.

Pull it out from front.

Loose terminal screw and insert cable end fully into terminal block, then tighten it.

Pull the cable gently to make sure it is tight.

Replace cover after wiring.

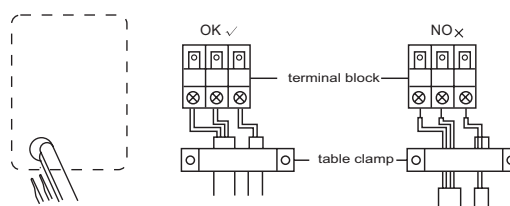

Note:

- When connecting indoor and outdoor wire, check the number on indoor and outdoor terminal blocks. Terminals of same number and same color shall be connected by the same wire.
- Incorrect wiring may damage air conditioner's controller or cause operation failure.

### Indoor & outdoor unit connection

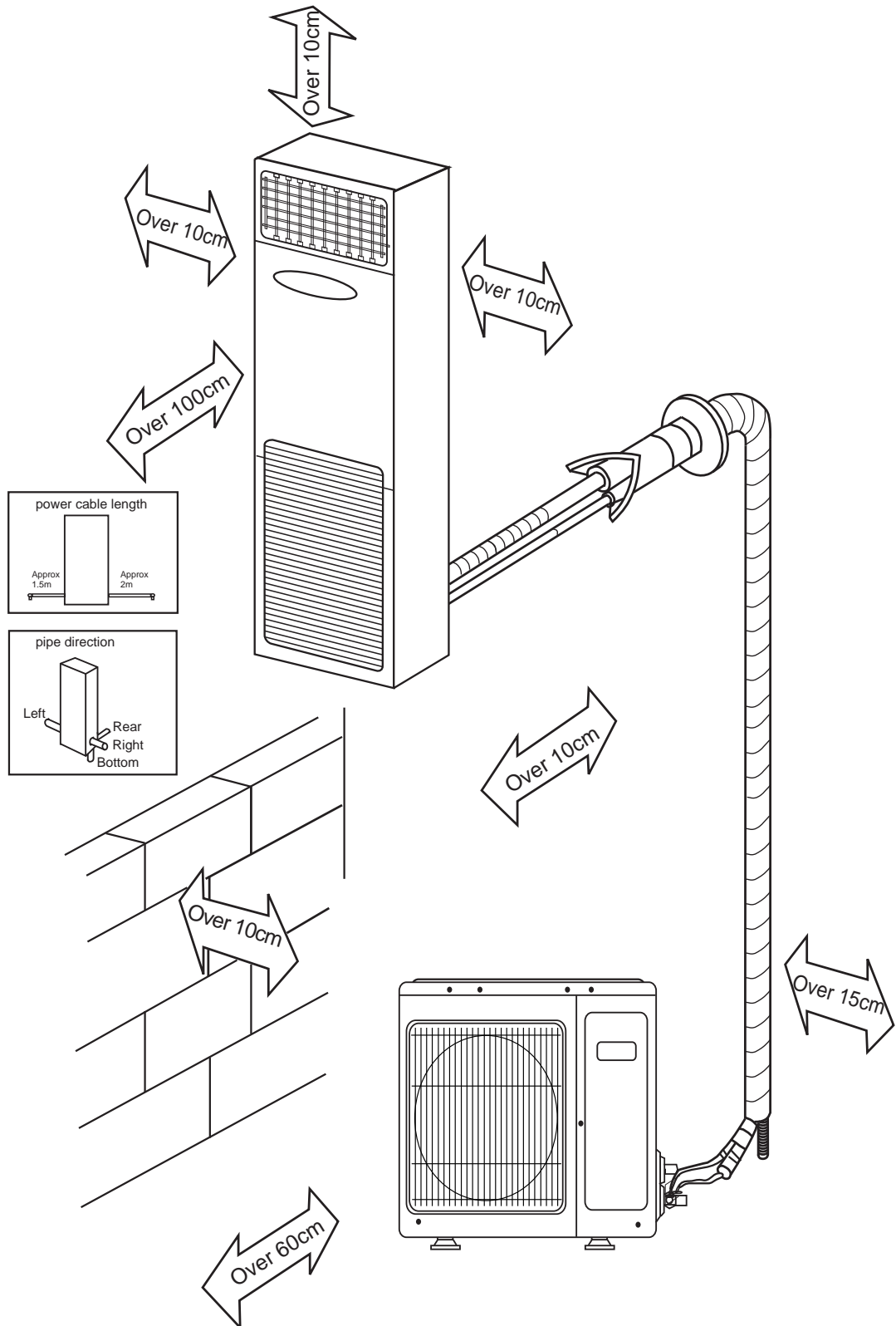

### 6. Parts and Functions

#### 6.1 HBU-18CF03

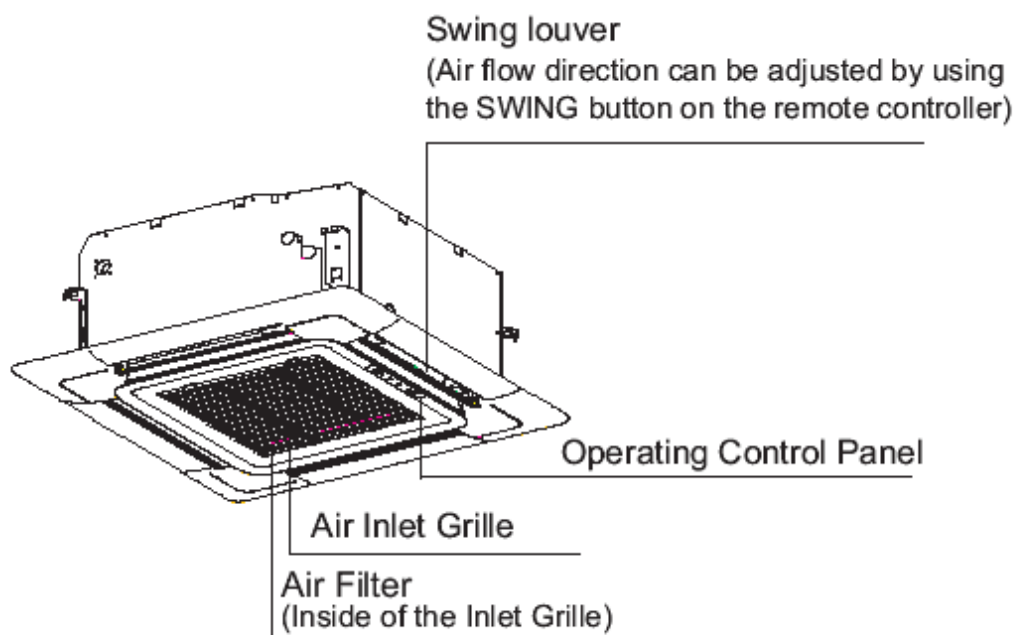

#### Operating Control Panel

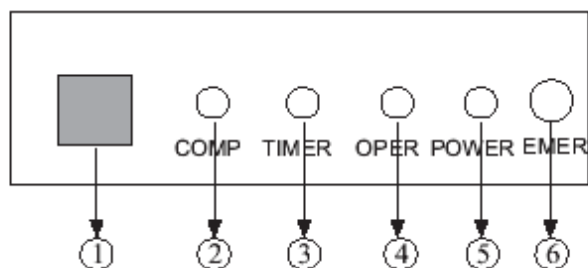

- ① Remote receiver
- ② Compressor Lamp
- ③ TIMER Lamp
- ④ OPERATION Lamp
- ⑤ Power Lamp
- ⑥ Emergency switch

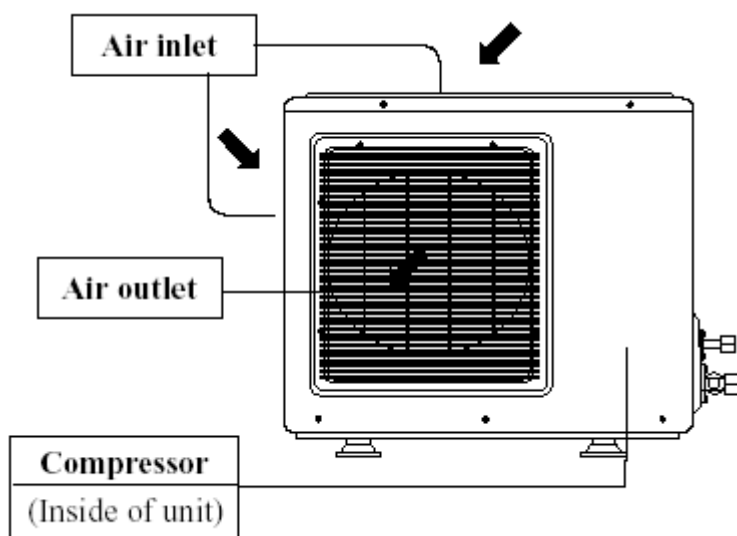

### 6.2 HDU-42CF03/H

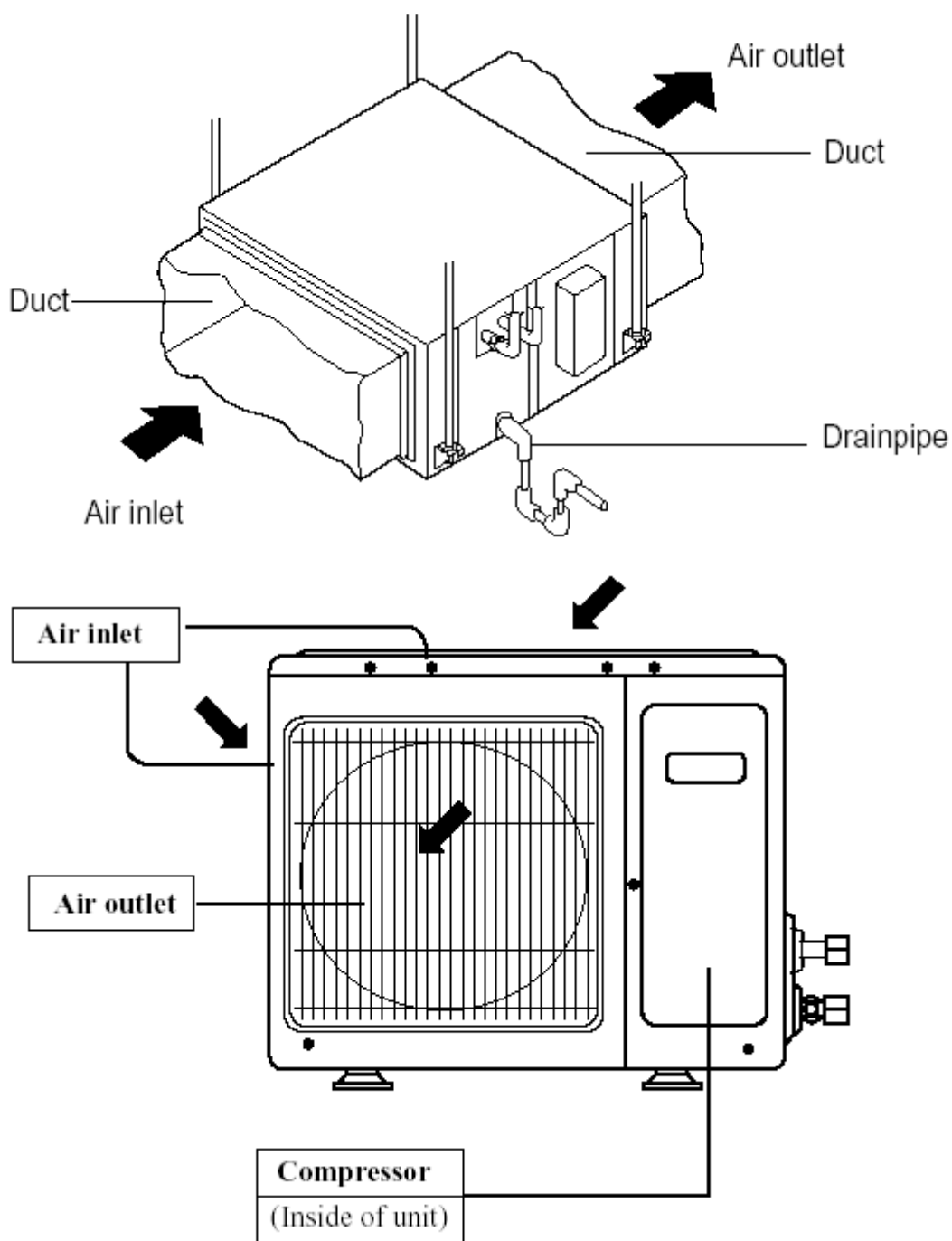

### 6.3 HPU-42HF03

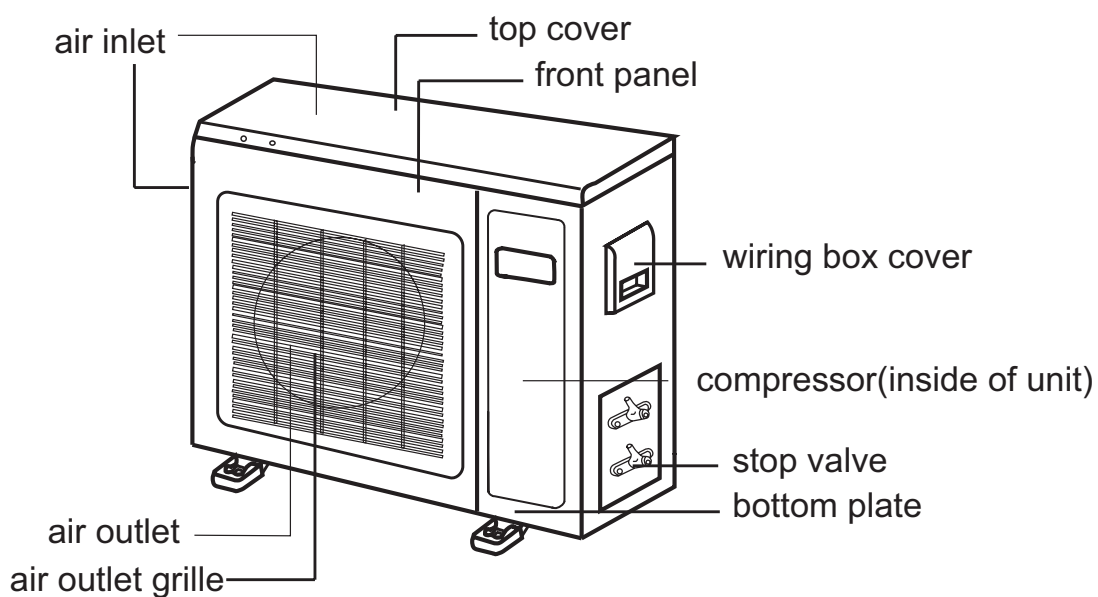
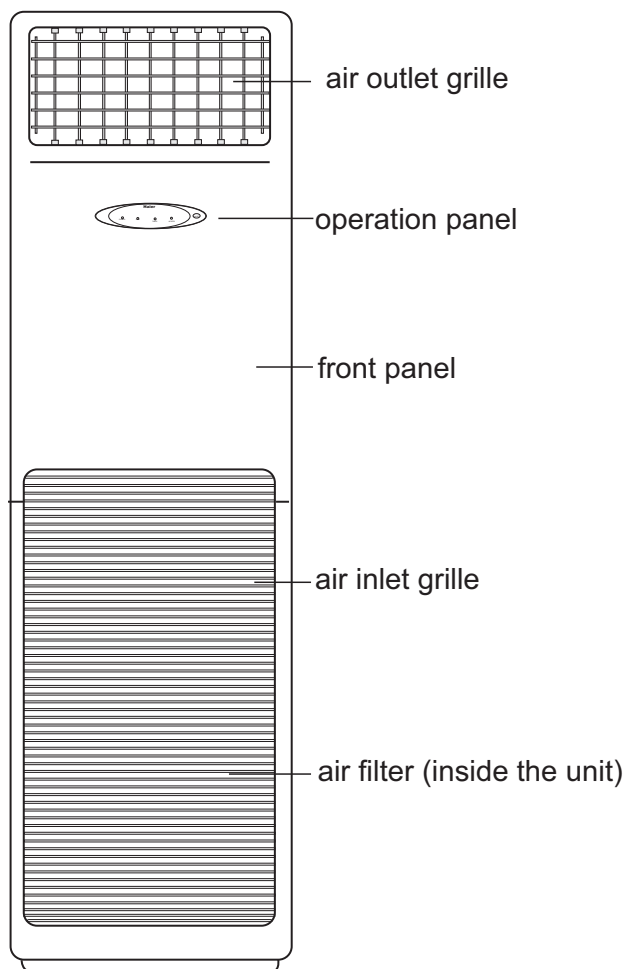

## 7. Remote controller functions

### 7.1 Remote controller YR-H71

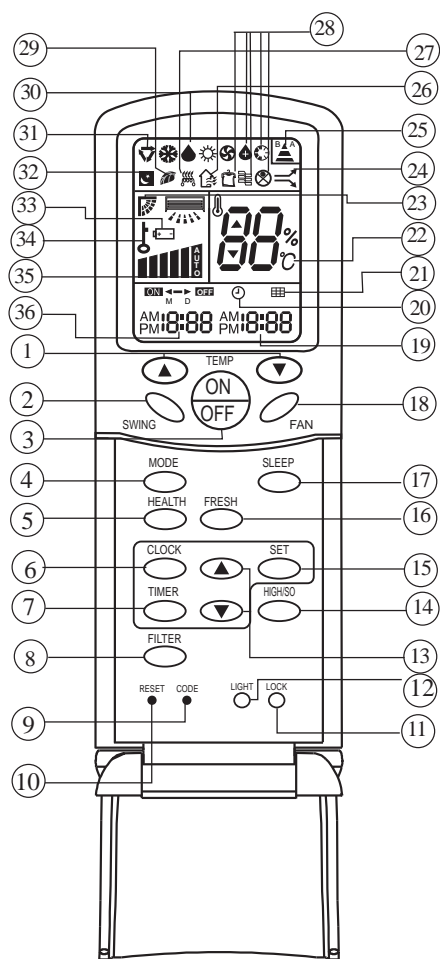

#### 1. TEMP Setting Button

(Used to set temperature. Setting ranges: 16°C to 30°C)

In Up/Down function, for controlling up and down filter.

#### 2. SWING Button

If you press this button once, auto swing will be activated.

If you press this button again, the louver will fix in the present position.

#### 3. Power ON/OFF Button

Used for unit start and stop

After power on, the LCD of remote controller will display the previous operation state (except for TIMER, SLEEP and SWING state).

**NOTE:** 1. Cooling only air conditioner does not have the displays and functions related to heating.

2. HIGH/SO button

This button is activated in Cooling/Heating mode, the fan speed is in AUTO mode after pressing it and "high function" will be cancelled automatically after 15 minutes running.

## 4. Operation MODE

Used to select operation mode.

Every time you press MODE button, operation mode changes according to following sequence:



## 5. HEALTH Button

Used to set health mode, if the unit has the negative ion function and oxygen bar function.

## 6. CLOCK Button

Used to set correct time.

## 7. CLOCK Button

Used to select TIMER ON, TIMER OFF.

(Note: if time of TIMER ON is the same as TIMER OFF, TIMER ON/OFF cannot be set)

## 8. FILTER Button

Used to set up/down function of filter.

## 9. CODE Button

Used to select code A or B, for this unit, the code is A.

## 10. RESET Button

Press this button by using a sharp article to resume the correct operation of the remote controller in case of need, i.e. for example in case of malfunctions due to electromagnetic noise.

## 11. LOCK Button

Used to lock operation button and LCD display contents: by pressing this button, other buttons comes out of function and lock state display appears; if you press it again, lock state will be no more active and lock state display will disappear.

## 12. LIGHT Button

Used to light the control panel (only for cabinet unit)

## 13. Up and down Button

Used to set TIMER and CLOCK up or down.

## 14. HIGH/SO Button

Used to select HIGH or SOFT operation.

## 15. SET Button

Used to confirm TIMER and CLOCK settings.

## 16. FRESH Button

Used to set fresh mode, the unit will draw in fresh air.

## 17. SLEEP Button

(The clock must be corrected before setting sleep function)

Used to set sleep mode.



### 18.FAN Button

Used to select fan speed:LOW,MID,HIGH,AUTO.

### 19.TIMER OFF Display

### 20.CLOCK Display

### 21.FILTER Display

### 22.TEMPERATURE Display

### 23.AUTO SWING Display

### 24.HIGH/SO Display

### 25.SIGNAL SENDING Display

### 26.FRESH AIR Display

### 27.ELECTRICAL HEATING Display

### 28.Some other buttons

All these functions are not available now.

### 29.HEALTH Display

Displays when healthy run function is set.

### 30.DEHUMIDIFICATION Display

### 31.Operation MODE Display

| AUTO RUN | COOL RUN | DRY RUN | HEAT RUN | FAN RUN |
|----------|----------|---------|----------|---------|
|          |          |         |          |         |

### 32.SLEEP State Display

### 33.BATTERY Energy Display

Notify the user when it is time to change the batteries.

### 34.LOCK State Display

### 35.FAN SPEED Display

|      |  |  |
|------|--|--|
| LO   |  |  |
| MID  |  |  |
| HI   |  |  |
| AUTO |  |  |

### 36.TIMER ON Display

#### Remote Controller' Operation

- When in use, direct signal transmission head to the receiver placed on the indoor unit

- The distance between the remote controller and the receiver should be max 7m and there should be no obstacle between them.
- Do not throw the remote controller; prevent it from being damaged.
- When operating the remote controller in an area where electronically controlled lights are installed or wireless handsets are used, please move closer to the indoor unit as the function of the remote controller might be affected by signals emitted by the above mentioned equipments.

#### Battery loading

Battery loading

Batteries are fitted as follows:

Remove the battery compartment lid

Slightly press and disengage the battery compartment lid marked with and then hold the remote controller by the upper section and then remove the battery compartment lid by pressing in the direction of the arrow as shown in the figure above.

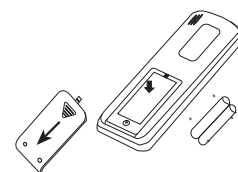

#### Loading the battery

Ensure that batteries are correctly placed in the compartment as required for positive and negative terminals.

#### Replacing the battery compartment lid

The battery compartment lid is reinstalled in the reverse sequence.

#### Display review

Press the button to see if batteries are properly fitted. If no display appears, refit the batteries.

#### Confirmation indicator

If no indication is displayed after press ON/OFF button, reload the batteries.

Caution:

If the remote controller does not operate as designed after fitting new batteries of the same type, press the Reset button (marked ) with a pointed article.

Note:

It is recommended that the batteries be removed from the compartment if the remote controller is not used for an extended period.

The remote controller is programmed for automatic test of operation mode after the batteries are replaced. When the test is conducted, all icons will appear on the screen and then disappear if the batteries are properly fitted.

#### Clock Set

When unit is started for the first time and after replacing batteries in remote controller, clock should be adjusted as follows:

- 1.Press CLOCK button, clock indication of " AM " or " PM " flashes.
- 2.Press or to set correct time. Each press will increase or decrease 1 min. If the button is kept pressed, time will increase or decrease quickly.
- 3.After time setting is confirmed, press "SET" : AM or PM stop flashing, while clock starts working.

Note:AM means morning and PM means afternoon.

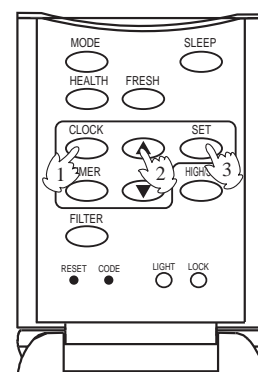

### Fan Operation

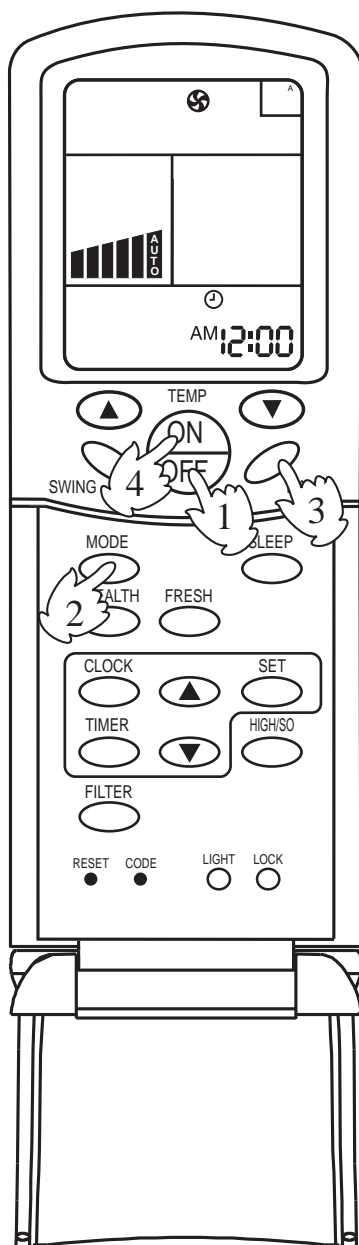

#### 1. Unit start

Press ON/OFF button to start your air conditioner. Previous operation status appears on LCD (except for TIMER, SLEEP, and SWING setting).

#### 2. Select operating mode

Press MODE button. At each press, operation mode changes as follows:

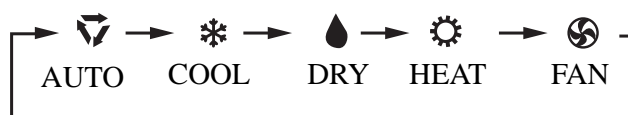

Then select FAN

#### 3. Adjust fan speed

Press FAN button. At each press, fan speed changes as follows:



Air conditioner will run at the selected fan speed. When in AUTO mode, unit will adjust fan speed according to room temperature automatically.

#### 4. Unit stop

Press ON/OFF button to stop unit.

#### About FAN mode

When the air conditioner runs in FAN mode, it is not possible to select AUTO FAN or to set temperature.

### AUTO, COOL, HEAT and DRY Operation

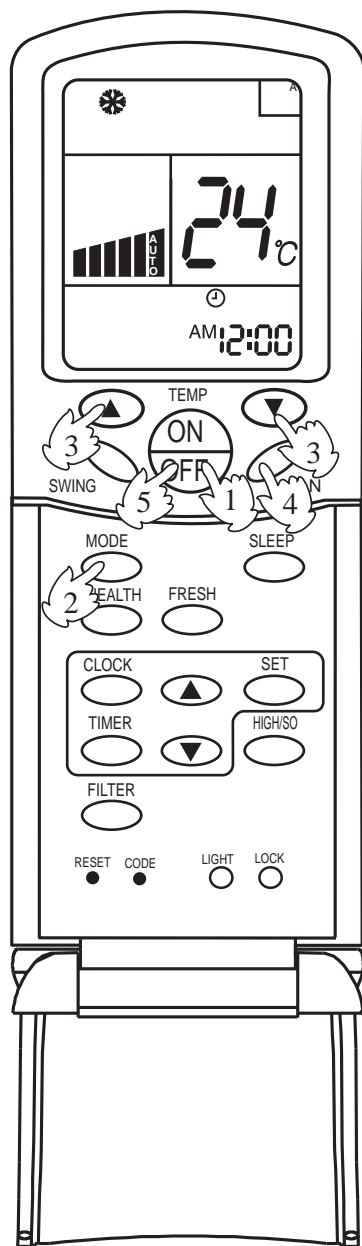

#### 1. Unit start

Press ON/OFF button, unit starts.

Previous operation status appears on LCD (except for TIMER, SLEEP and SWING setting)

#### 2. Select operation mode

Press MODE button. At each press, operation mode changes as follows:

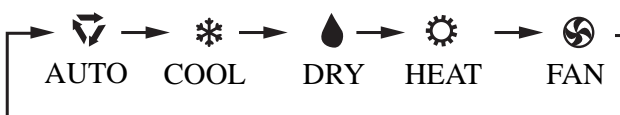

Then  or  or  or

#### 3. Temperature setting

Press TEMP button.

- ▲ Every time the button is pressed, temp. setting increases 1°C; if the button is kept pressed, temp. setting will increase quickly.
- ▼ Every time the button is pressed, temp. setting decreases 1°C; if the button is kept pressed, temp. setting will decrease quickly.

Set proper temperature

#### 4. Adjust FAN button

Press FAN button. At each press, fan speed changes as follows:

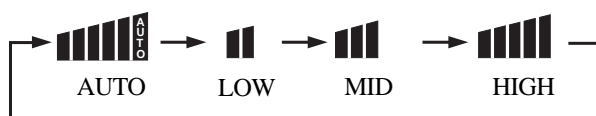

Air conditioner will run at the selected fan speed.

#### 5. Unit stop

Press ON/OFF button, unit stops.

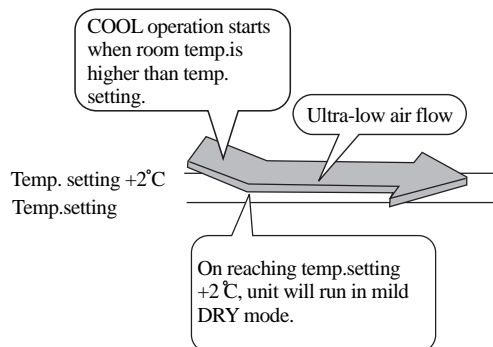

In ATUO mode, the temperature setting is not displayed on LCD. In this mode, during running air conditioner will select COOL, HEAT or FAN mode automatically according to the room temperature.

In DRY mode, when room temperature becomes 2°C higher than temperature setting, unit will run intermittently at LOW speed regardless of FAN setting. When room temperature is lower than temperature setting, unit will only run FAN operation.

In HEAT mode, warm air will blow out after a short period of time due to cold-draft prevention function.

### Adjusting air flow direction

#### AUTO SWING

Press SWING button.

Up and down airflow varies upwards and downwards. Left and right airflow varies left and right sides.

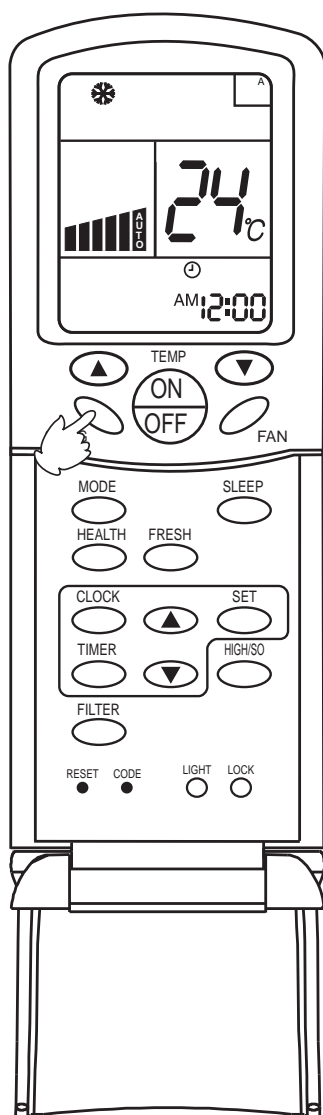

#### AUTO SWING

When the automatic swing louver moves to the proper angle, press SWING button can fix the airflow direction.

- Always use SWING button on the remote controller to adjust flaps. Adjusting them by hand may result in air conditioner's abnormally running.
- In COOL or DRY mode, do not leave the louver in downward position for a long time, as the water vapor close to the grille may condense and water may drop from the air conditioner.
- Please carefully set temperature when children, old or infirm people uses the air conditioner.
- In case of great humidity, If the vertical flaps are completely turned towards left or right, the louver will drop water.
- Never adjust the louver directly by hand, as this could make it work abnormally. If the louver work abnormally, stop unit, restart and adjust the louver by remote controller.

After unit stops:

Displays on the LCD disappear.

All indicators on the indoor unit go out.

Swing louver automatically close the air outlet.

#### Hints:

As in COOL mode air flows downwards, adjusting airflow horizontally will be much more helpful for a better air circulation

As in HEAT mode air flows upwards, adjusting airflow downward will be much more helpful for a better air circulation.

Be careful not to catch a cold when cold air blows downward directly.

### Sleep Function

Before going to bed you can press down the SLEEP button and the air conditioner will run so as to make you sleep more comfortably.

Before using this function, the clock must be set.

### Use of SLEEP function

After the unit's start, set running mode and then press SLEEP button once to make the air conditioner have the previous-set sleep time (first power-on is "1h"). The sleep symbol will appear. Press time button ▲/▼: you can choose the time in 1~8 hours. Each time the button is pressed, the time increases/decreases 1 hour: "xh" and "OFF" indications appear on the display.

### Operation Mode

#### 1. In COOL, DRY mode

One hour after sleeping operation start, the temperature is 1°C higher than the setting one. After another hour, temperature rises 1°C: sleep run continuously for another 6 hours and then stops. The actual temperature is higher than the setting one which is to prevent from being too cold to your sleep.

#### 2. In HEAT mode

One hour after sleeping operation start, the temperature is 2°C lower than the setting one. After another hour, temperature decreases by 2°C more. Temperature will automatically rise by 1°C after another 3 hours' continuous operation. The actual temperature is lower than the setting one which is to prevent from being too hot to your sleep.

#### 3. In AUTO mode.

The air conditioner will run in corresponding sleep operation according to the automatically selected operation mode.

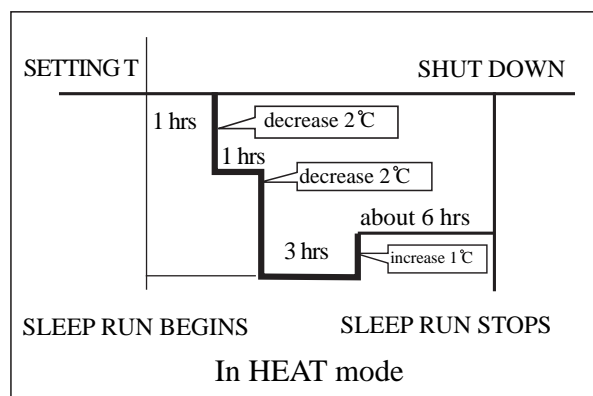
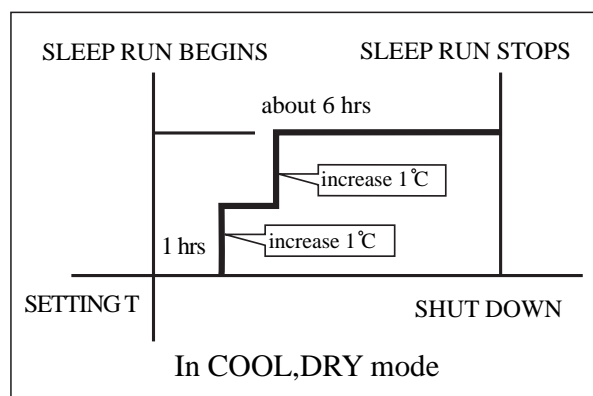

#### Notes:

- After setting SLEEP function, it is not possible to set clock.
- If set-sleep time does not reach 8 hours, unit will automatically stop operation after set time is reached.
- Set "TIMER ON" or "TIMER OFF" in COOL, DRY mode function first, then set SLEEP. After set SLEEP function, the TIMER function cannot be set.

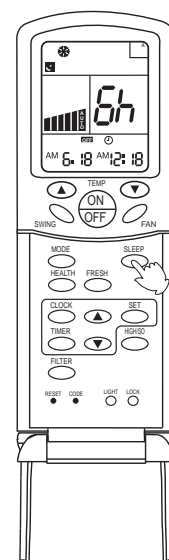

### Timer ON/OFF Function

Set clock correctly before starting TIMER operation

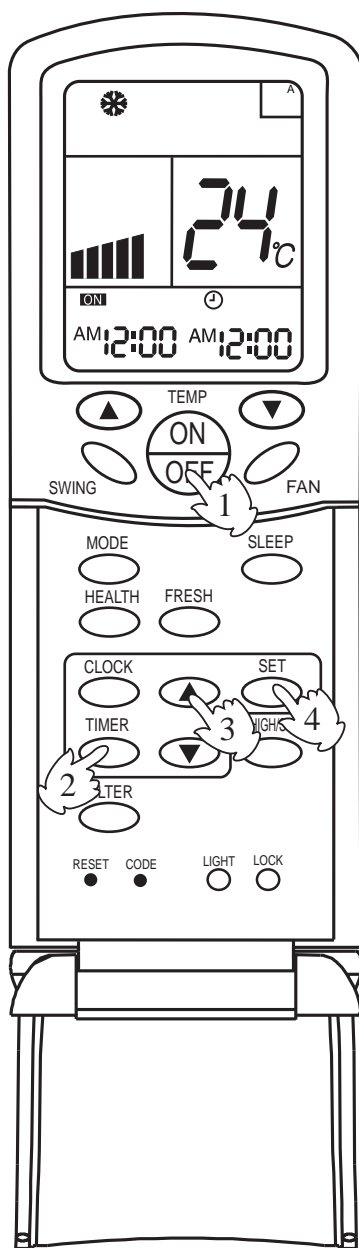

#### 1. Unit start

After unit start, select your desired operation mode (operation mode will be displayed on LCD)

#### 2. TIMER mode selection

Press TIMER button on the remote controller to change TIMER mode. Every time the button is pressed, display of TIMER mode changes as follows:



Then select TIMER mode as needed (TIMER ON or TIMER OFF). Now **ON** or **OFF** will flash.

#### 3. TIMER setting (press time adjust buttons $\blacklozenge$ )

- ▲ Every time the button is pressed, time increases 10 minutes. If the button is kept pressed, time changes quickly.
- ▼ Every time the button is pressed, time decreases 10 minutes. If the button is kept pressed, time changes quickly. It can be adjusted within 24 hours at will.

#### 4. Confirm setting

After setting correct time, press SET button to confirm time. Now **ON** or **OFF** stop flashing.

Time displayed: unit starts or stops at X hour X min (TIMER ON or TIMER OFF)

#### 5. Cancel TIMER mode

Just press TIMER button several times until TIMER mode disappears.

#### Hints:

After replacing batteries or if a power failure occurs, TIMER setting must be reset.

Remote controller has memory function. When you use TIMER mode next time, just press SET button after mode selection if timer setting is the same as the previous one.

#### Note:

After setting TIMER function, the remote controller displays TIMER time. If you want to see clock time, just press CLOCK button once: clock time will be displayed (if you press the button again continuously, you can adjust clock). 5 seconds later, the display will show TIMER time again.



### Timer ON-OFF Function

Set clock correctly before starting TIMER operation

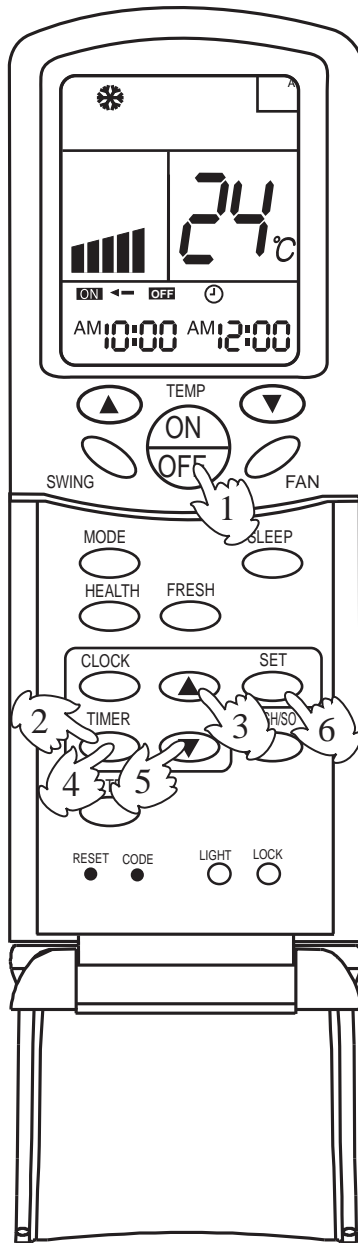

#### 1. Unit start

After unit start, select your desired operation mode (operation mode will be displayed on LCD)

#### 2. TIMER mode selection

Press TIMER button on the remote controller to change TIMER mode. Every time the button is pressed, display of TIMER mode changes as follows:

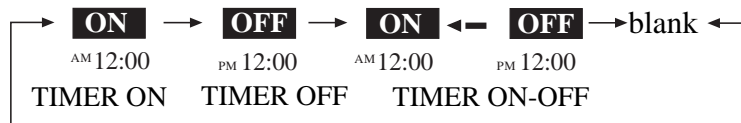

Then select TIMER ON-OFF mode. **ON** will flash.

#### 3. Time setting for TIMER ON

Press time button  $\blacklozenge$

$\blacktriangle$  Every time the button is pressed, time increases 10 minutes. If the button is kept pressed, time will change quickly.

$\blacktriangledown$  Every time the button is pressed, time decreases 10 minutes. If the button is kept pressed, time will change quickly. It can be adjusted within 24 hours at will. AM refers to morning and PM refers to afternoon.

#### 4. Timer confirming for TIMER ON

After setting correct time, press TIMER button to confirm time. Now **ON** stops to flash, while **OFF** starts flashing.

Time displayed : unit starts at X hour X min.

#### 5. Timer setting for TIMER OFF

Press time buttons  $\blacklozenge$  and follow the same procedures in " Time setting for TIMER ON"

#### 6. Time confirming for TIMER OFF

After time setting, press SET button to confirm time. **OFF** stops to flash.

Time displayed: unit starts at X hour X min.

#### 7. Canel TIMER mode

Just press TIMER button several times until TIMER mode disappears.

According to the time setting sequence of TIMER ON and TIMER OFF, either start-stops or stops-start can be realized.

If the time setting of TIMER ON is the same as TIMER OFF, TIMER ON-OFF function cannot be set.

## Filter Up/Down (Optional)

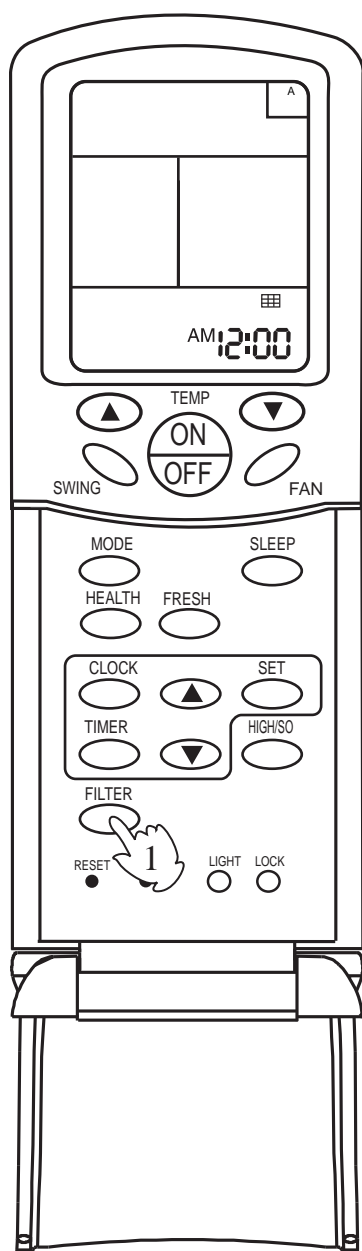

After the air conditioner has operated for a certain period, dust has accumulated on the filter, and the filter up/down function can be used to clean it.

1. Whether unit starts or stops, continuously press FILTER button for 3 seconds, and enter the filter up/down waiting status (when unit stops, the yellow TIMER indicator flashes, and filter and clock indication are displayed on the remote controller. Only the FILTER button, the temperature buttons "Δ" "▽" and time buttons ▲ ▼ are active).
2. Press temperature "▽" button or time "▼" button in filter up/down waiting status: the up/down mechanism makes the filter moving downward and does not stop until it has reached the maximum limit.
3. Press temperature "Δ" button or time "▲" button in filter up/down waiting status: the up/down mechanism makes the filter to moving upward till near the surface board and then automatically adjusts it to reset (when adjusting to reset, it will not be controlled by the remote controller till the adjustment is finished).
4. During moving downward, press temperature "Δ" button or time "▲" button: moving stops.
5. During moving downward, press temperature "▽" button or time "▼" button: moving stops.
6. Continuously press FILTER button 3 seconds again to cancel the filter up/down waiting mode (unit stops, the yellow timer indicator stops flashing, the filter goes back to the original position, the remote controller goes back to off status and only clock is displayed).

### Note:

If the filter does not thoroughly go back to the original position, only needs to operate several times repeatedly.

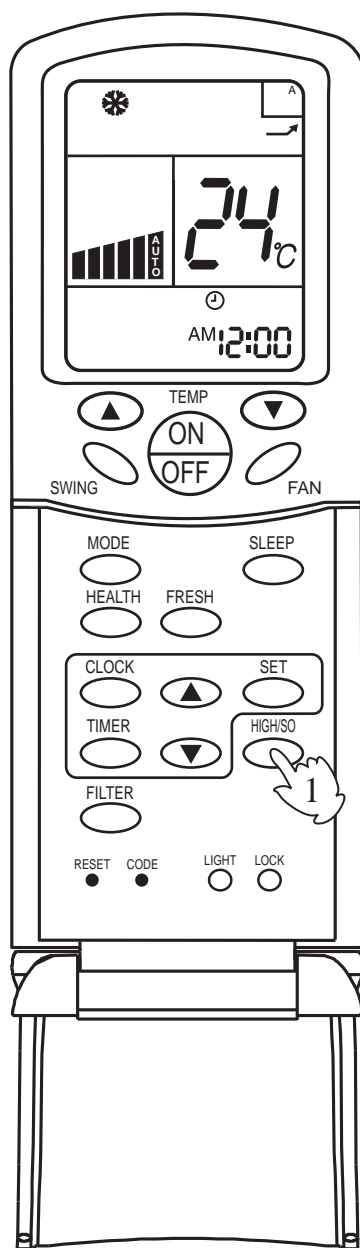

## " High mode " Operation

**Outline of operation in "High Mode"**

This function is suitable when the set temperature must be reached in the shortest delay.

The button "HIGH/SO", referred to this function, is effective in Cooling/Heating mode (not in Auto/Dry/Fan modes).

**ON****Press the HIGH/SO button once**

The indication  appears on the display of the remote controller and operation in "High Mode" starts.

The AUTO fan speed is automatically set and the corresponding indication is also displayed.

**OFF****Press the HIGH/SO button twice**

If the button is pressed once, the indication  is displayed on the remote controller. If you press the button once again, the indication disappears, regular operation is restored and fan speed goes back to the mode set before "High Mode" operation.

**NOTICE:**

- When the air conditioner is operating in " High Mode " , unevenness of room air temperature may occur due to the intensive operation in a short time.
- Anyway, operation in "High Mode", does not last for more than 15 minutes, then regular operation is automatically restored.

### " Soft mode " Operation

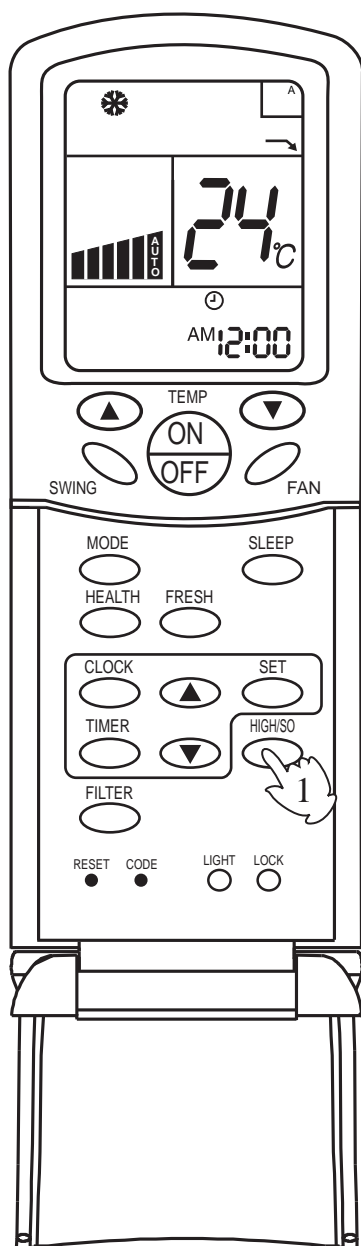

#### Outline of operation in "Soft Mode"

Operation in "Soft Mode", more silent, is suitable when noises should be reduced, e.g.. for reading or sleeping.

The button "HIGH/SO", referred to this operation, is effective in Cooling/Heating mode (not in Auto/Dry/Fan modes).

#### ON

##### Press the HIGH/SO button twice

The indication  appears on the display of the remote controller and operation in "Soft Mode" starts.

The AUTO fan speed is automatically set and the corresponding indication is also displayed.

#### OFF

##### Press the HIGH/SO button twice

If the button is pressed once, the indication  is disappears from the remote controller's display. If you press the button once again, regular operation is restored and fan speed goes back to the mode set before "Soft Mode" operation.

#### NOTICE:

- When the air conditioner is operating in " High Mode " , unevenness of room air temperature may occur due to the intensive operation in a short time.
- Anyway, operation in "High Mode", does not last for more than 15 minutes, then regular operation is automatically restored.

## Auto restart function setting

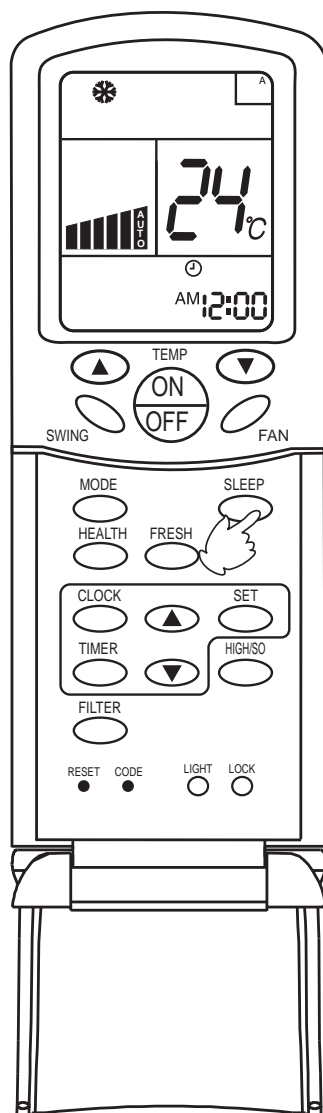
**Setting method (to be applied for a necessary situation) :**

After the power failure compensation is set, if power failure suddenly occurs while the air conditioner is working, it will resume the previous working state when the power is supplied again.

**Setting Method:** When the remote controller is on (excluding timer mode and fan mode), press the "Sleeping" button on the remote controller 10 times within 5 seconds, and after the buzzer rings 4 times, the air conditioner will enter the state of power failure compensation.

**Cancel Method:** Press the "Sleeping" button on the remote controller 10 times within 5 seconds, and after the buzzer rings 2 times, the power failure compensation mode will be cancelled.

**Notes:** When a power failure suddenly occurs during the air conditioner is working after the power failure compensation is set, if the air conditioner will not be used for a long time, please cut off the power supply to prevent its operation from being resumed after the power is supplied again, or press the "Switch On/Off" button after the power comes again.

### 7.2 Wired controller

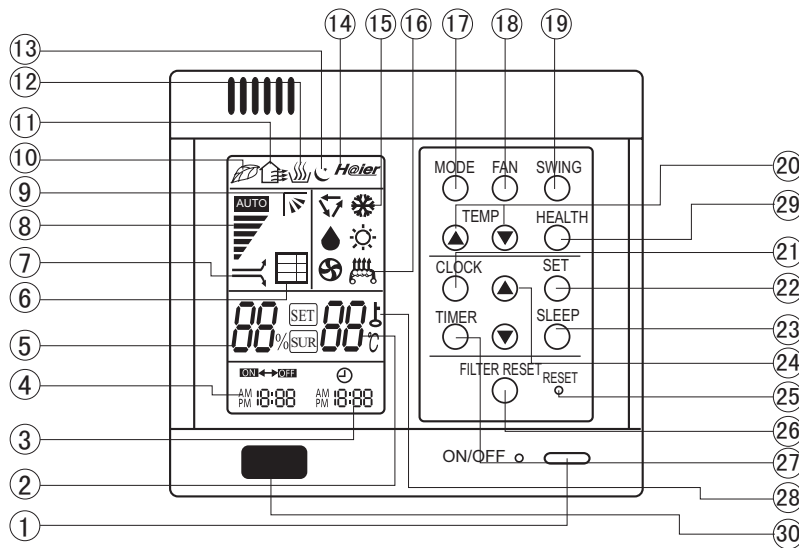

**1.ON/OFF button**

Used to turn on/off unit

**2.Temperature display**

**3.Clock display**

**4.Timer ON/OFF display**

**5.Humidity display**

**6.Air filter cleaning display**

When there is too much dust collected on the air inlet, the wire controller will show this display to remind the user to clean the air inlet. After cleaning and installation, just press the air filter reset button.

**7.Super/Soft operation display**

**8.Fan speed display**



**9.Auto Swing display**

**10.Health state display**

**11.Fresh air state display**

**12.Humidifying state display**

**13.Sleep state display**

**14.Network control display**

**15.Working mode display**

| Working mode    | Auto operation | Cooling operation | Dehumidifying operation | Heating operation | Fan operation |
|-----------------|----------------|-------------------|-------------------------|-------------------|---------------|
| Wire controller |                |                   |                         |                   |               |

**16.Electric heating display**

**17.Operation mode button**

Used to set working mode: Auto, Cooling, Dehumidifying, Heating, Fan

**18.Fan speed button**

Used to set fan speed: Low Fan, Med Fan, High Fan, Auto

**19.Swing button**

Used to set Auto Swing or Fixed air sending direction

**20.Temperature Setting button**

Used to set temperature, temperature range: 16 C~30 C

**21.Clock button**

Used to calibrate the time of timer and clock

**22.Setting button**

Used to confirm the time of timer and clock

**23.Sleep button**

Used to set Sleep state

**24.Time Adjusting button**

Used to adjust the time of timer and clock

**25.Reset button**

When the wire controller appears abnormal condition, use a sharp-pointed article to press this button to make the wire controller resume normal

**26.Air Filter Reset button**

After cleaning the air inlet, press this button, the unit can start to operate

**27.Timer button**

Used to set the mode of timer

**28.Lock state display**

**29.Health**

Used to control the generating oxygen function and negative ion-function

**30.Remote control window**

Used to receive the remote control signal

Note: 1.This model does not have the following related display and function (5)(6)(7)(9)(11)(12)(14)(16)(26)  
2.The outdoor unit no oxygen-bar function or no negative ion unit no (10)(29) health function and health display.

**Calibration of clock**

When turning on the unit for the first time, the clock should be calibrated. The method of calibration is:

- 1.Press "Clock" button, the Clock display "AM" "PM" will flash.
- 2.Press ▲ or ▼ to adjust time. For each press, the time will increase or decrease 1 minute. If depressing the button, the time will increase or decrease rapidly.
- 3.After confirming the time, press "Set" button, "AM" or "PM" will stop flashing, the clock will begin to work.

### Recommendations

- Use COOL in summer.
- Use HEAT in winter.
- Use DRY in spring, autumn and in damp climate.

#### (1) Unit

Press ON/OFF button, unit starts.  
Previous operation status appears on display  
(Not Timer setting). Power indicator lights up.

#### (2) Select operation

Press MODE button. For each press, operation mode changes as follows:



Unit will run in operation mode displayed on LCD. Stop display at your desired mode.

#### (3) Select temp.

Press TEMP button

- ▲ Every time the button is pressed, temp. setting increases  $1^{\circ}\text{C}$ .  
If button is kept depressed, temp. setting will increase quickly.
- ▼ Every time the button is pressed, temp. setting decreases  $1^{\circ}\text{C}$ .  
If button is kept depressed, temp. setting will decrease quickly.  
Unit will start running to reach the temp. setting on LCD.

#### (4) Fan speed

Press FAN button. For each press, fan speed changes as follows:

Wire controller



Remote controller



- Auto running: During the Auto running mode, air conditioning running and can auto-select the cooling, heating, fan mode according to the room temperature.
- Fan running: The AC only have air supply running no cooling and heating running at the condition, AC can't have auto air supply running, and can't display the setting temperature value on the LCD.
- During the heating running, after start the AC, in order to prevent cooled air, AC can stop for a while before send heat air.
- During the dehumidification running, when the room temp. setting temp., not setting condition according to the air speed.

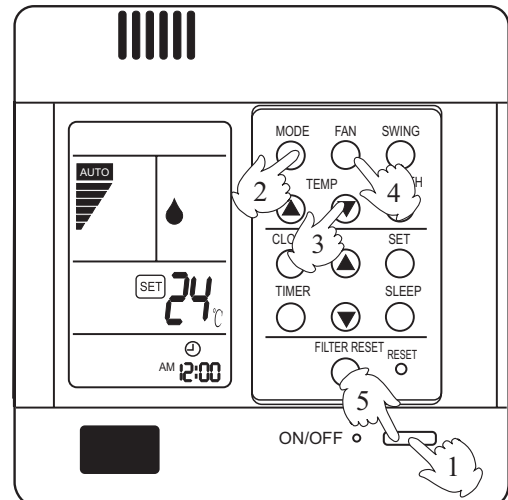

Unit runs at the speed displayed on LCD. In HEAT mode, warm air will blow out after a short period of time due to cold-draft prevention function.  
In DRY mode, when room temp. becomes  $2^{\circ}\text{C}$  higher than temp. setting, unit will run intermittently at LOW speed regardless of FAN setting.

#### (5) Unit stop

Press ON/OFF button.  
Only time and room temp remains on LCD.  
All indicators go out.  
Vertical flap closes automatically.

#### Hint

Wire controller can memorize each operation status.  
When starting it next time, just press ON/OFF button and unit will run in previous status.

### Set Clock correctly before starting Timer operation.

You can let unit start or stop automatically at following time: Before you wake up in the morning, or get back from outside or after you fall asleep at night.

### TIMER

#### (1)After unit start, select your desired operation mode.

Operation mode will be displayed on LCD. Power indicator lights up.

#### (2)TIMER mode selection

Press TIMER button to change TIMER mode. Every time the button is pressed, display changes as follows:



Select your desired TIMER mode (ON or OFF)

#### (3)Timer setting

Press TIME ▲/▼ button.

- ▲ Every time the button is pressed, time increases 10min. If button is kept depressed, time will change quickly.
  - ▼ Every time the button is pressed, time decreases 10min. If button is kept depressed, time will change quickly.
- Time will be shown on LCD. It can be adjusted within 24hours.

#### (4)Confirming your setting

After setting correct time, press SET button to confirm "ON" or "OFF" stops flashing. Time displayed: Unit starts or stops at x hour x min (ON or OFF). Timer mode indicator lights up.

### To cancel TIMER

Just press TIMER button several times until TIMER mode disappears.

- According to the setting timing open, close sequence, can realize first open then close the unit or first close then open the unit.

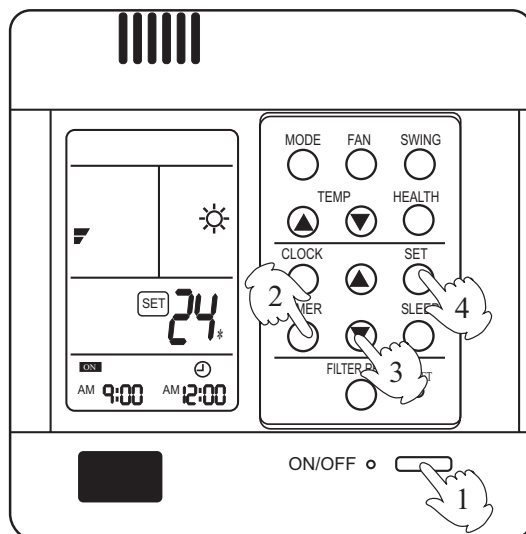

- Hints:**
- Wire controller possesses memory function, when use TIMER mode next time, just press SET button after mode selecting if timer setting is the same as previous one.
  - Wire remote controller or remote controller can memorize each working condition. Next time open the unit, only need to press the ON/OFF key, the AC can work according to last time working condition. (Timing, Sleeping and Swing mode not included.)
  - From Timing close to timing open, can setting sleep mode.
  - Please close health function first before setting Timer, then you can do the TIMER ON operation. Please do not use the health function when in TIMER ON state.

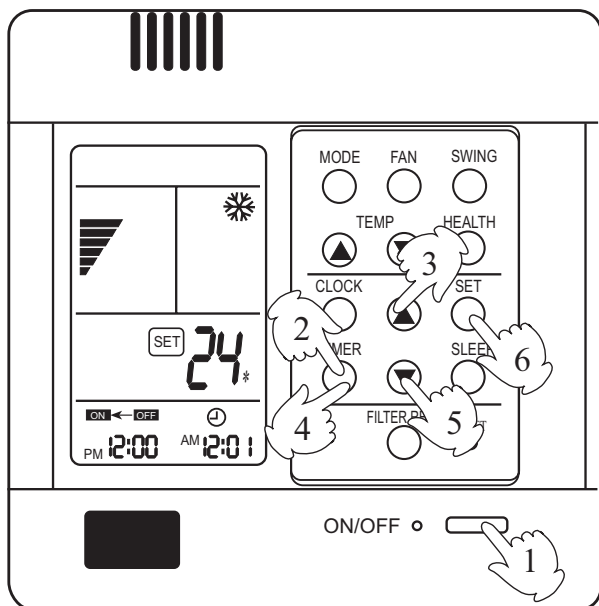

### TIMER ON-OFF

#### (1) After unit start, select your desired operation mode

Operation mode will be displayed on LCD. Power indicator lights up.

#### (2) Press TIMER button to change TIMER mode

Every time the button is pressed, display changes as follows:



Select <sup>ON</sup>  
<sub>OFF</sub> .

#### (3) Time setting for TIMER ON

Press TIME button.

- ▲ Every time the button is pressed, time increases 10min. If button is kept depressed, time will change quickly.
- ▼ Every time the button is pressed, time decreases 10min. If button is kept depressed, time will change quickly. Time will be shown on LCD. It can be adjusted within 24hours.

AM refers to morning and PM to afternoon.

#### (4) Time confirming for TIMER

After time setting, press TIMER button to confirm. "ON" stops blinking, While "OFF" starts blinking. Time displayed: Unit starts at Xhour X min.

#### (5) Time setting for TIMER OFF

Follow the same procedures in "Time setting for TIMER ON".

#### (6) Time confirming for TIMER OFF

After time setting, press SET button to confirm "OFF" stops flashing. Time displayed: Unit stops at X hour X min.

To cancel TIMER mode

- Just press TIMER button several times until TIMER mode disappears.
- According to the Time setting sequence of TIMER ON or TIMER OFF, either Start-Stop or Stop-Start can be achieved.



Note: Before using this function, must adjust the clock, or the sleep function will be disordered.

### Comfortable Sleep

At night, before going to bed you can press down the SLEEP button on the controller and the air-conditioner will run by the comfortable sleeping mode to make you sleep more comfortable.

Press SLEEP button once to make the air conditioner have the pre-set sleep time (first power-on is "1h"), the sleep symbol will appear. Press time button ▲/▼, you can choose the time in 1~8 hours. Each press of ▲/▼, the time increases/reduces 1hour and "xh" appear in the humidity setting area, "OFF" appears in "TIMER OFF" display area and timer-off time; press SLEEP button again to cancel sleep function, the sleep symbol disappears.

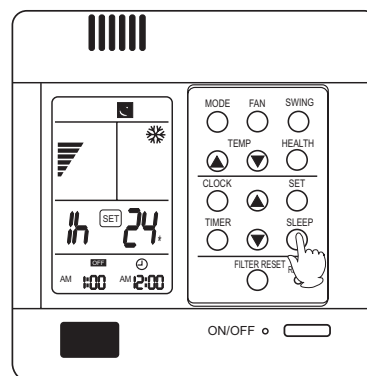

### In cooling, dehumidifying mode

One hour after sleeping operation start, the temp. is 1°C higher than the setting one. After another hour the temp. rises 1°C and then run continuously for another 6hrs' and then close. The actual temp. is higher than the setting one which is to prevent from being too cool to your sleep.

### In heating mode

One hour after start up, the temp. decrease 2°C lower than the setting one. After another hour decrease by more 2°C.

The temperature will automatically rise by 1°C after another 3hrs' operation, and then automatically close after 3hrs' continuous operation. The actual temperature is lower than the setting one which is to prevent from being too hot to your sleep.

**Note:** In AUTO mode, unit will run in SLEEP function according to the operation mode.

After setting SLEEP function, it is forbidden to calibrate clock.

If the set sleep-time does not reach 8 hours, the unit will stop operation automatically after set time is complete.

Set "TIMER-OFF" function first, then set SLEEP, and the sleep-set is performance; set TIMER-ON function first, the sleep function can only be set before TIMER-ON; if set the SLEEP function first, the TIMER function can not be set.

- After setting sleep function, not allowed to adjust the clock. Can't use the remote controller operate the AC. If so, please cancel the sleep function first.
- After setting sleep function, can't set the timing function.

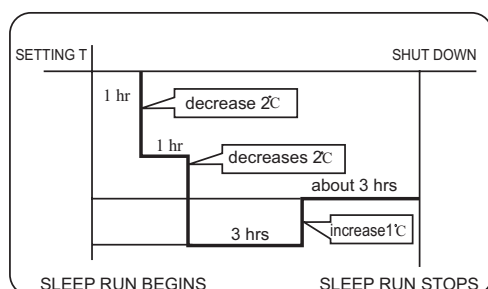

Heat mode

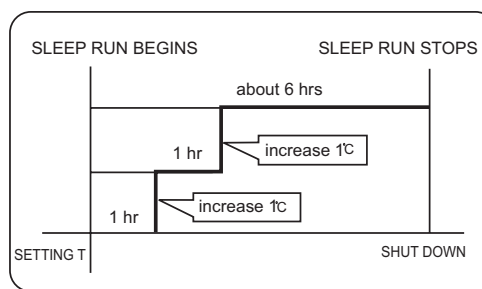

Cooling mode



**Auto restart function (to be applied for a necessary situation) :**

After the auto-restart function is set, if power failure suddenly occurs while the air conditioner is working, it will resume the previous working state when the power is supplied again.

Setting Method: When the remote controller is on (excluding timer mode and fan mode), press the "SLEEP" button on the remote controller 10 times within 5 seconds, and after the buzzer rings 4 times, the air conditioner will enter the state of auto-restart function.

Cancel Method: Press the "Sleeping" button on the remote controller 10 times within 5 seconds, and after the buzzer rings 2 times, the power failure compensation mode will be cancelled.

Notes: When a power failure suddenly occurs during the air conditioner is working after the power failure compensation is set, if the air conditioner will not be used for a long time, please cut off the power supply to prevent its operation from being resumed after the power is supplied again, or press the "Switch On/Off" button after the power comes again. If the controller no sleep key, use the "swing" key instead the "sleeping" on setting the auto restart function.

**Concerning MRV Auto Restart function for H-MRV models**

Haier Auto Restart function when the unit power drops down suddenly, the unit microprocessor will store the previous working condition and when the power is on again, the unit will run as this memory.

Auto Restart function is designed basically on the MRV whole system, but it is suitable for each indoor unit individually.

If some of indoor units power cut down, but the outdoor unit and the other indoor units still work, maybe problems will happen such as freezing at cooling mode and overload protection at heating mode on those indoor units without power.

**Reason**

When one or some indoor units power drops down and the other indoor units are still work, the indoor units without the power, will keep the previous working condition before the power is off. And expansion valve keeps open at a kind of opening rate condition as the previous requirement, so there is refrigerant flowing in the exchanger, but the indoor fan stops working. If the units work at cooling mode, the indoor units without the power will maybe make freezing. If the unit works at heating mode, maybe the outdoor unit compressor will stop because of the pressure or temperature protection. This is our design basically on Auto Restart function currently.

Haier, Herewith, solemnly informs our customers, installers, distributors, etc. **when making installation, please make sure when the power is shut down whether artificially or accidentally, the whole system including outdoor unit and all the indoor units must be off. If you do not make the installation as our indication, Haier will not be responsible for any problem resulting from this.**

**User Caution**

About the remote control operation, above only take wired remote controller and remote controller as a example about the remote controller and remote receiver use method, it is the same remote controller, please use refer to above method.

No sleep function when use remote and remote receiver.

### About health function

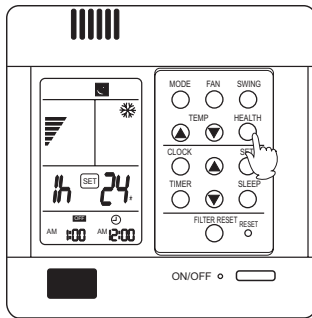

- On the "Health" mode, if you want to setting timing open mode, should close the health first: On the timing open mode, please don't use health function.

1.How to use the health function (only for units with this function)  
 After set the right function mode, press health button, remote controller or wire controller displays "🌿",oxygen pump or negative ion generator starts up to apply oxygen or negative ion to indoor unit. Press the button again,the sign "🌿" disappeared and negative ion generator stops working. After all health function of the indoor unit being fully canceled, oxygen pump stopped.

**CAUTION:**

When the temperature of the outdoor unit is lower than 4°C , oxygen pump is automatically stopped, if press health button just then, oxygen pump could not start up. But if the air conditioner has the negative ion function simultaneous,when press the health button, negative ion function could still be operated. When the temperature of the outdoor unit is higher than 6°C , oxygen pump could automatically resume to oxygen-make function.

For H-MRV wired type indoor unit, the wired controller can be matched with the remote controller YR-H71 to realize the remote control function.

Left picture is a wired remote controller, which can be used on Series wired control units ,The remote controller can be purchased extrally.

Wired remote Controller using method:

- 1.Use one wired remote controller. See fig (1)
- 2.Also can buy a remote controller extrally, realize wired remote control + remote control dual control modes.

**3.When the remote controller can be used on series wired remote controller units ,than please press the botton "CODE"to choose the program of code "A"**

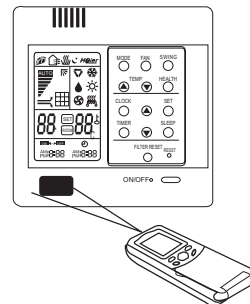
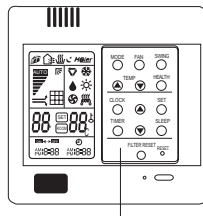
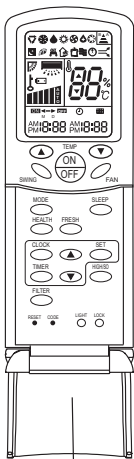

### 1. Remove upper cover of wire controller

Remove upper part of wire controller by press.

PCB is mounted on lower part of wire controller, be careful not to damage it.

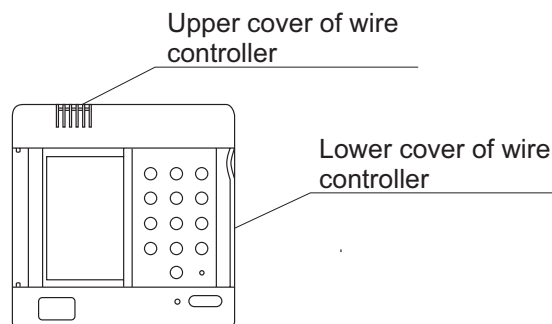

### 2. Install the wired remote controller

Please drill two holes on the wall according to the back cover screw hole position of the wire remote controller, then strike the wood block to the holes respectively, then align the 2 screw hole of the wire controller back cover to the wood block, fasten the wire remote controller to the wall use wood screws.

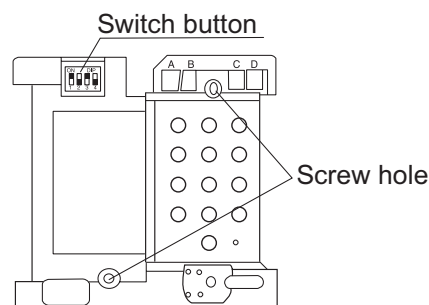

### 3. Switch setting

The switches setting as follows: 1.ON 2.OFF 3.ON 4.OFF

#### Note

Try as far as possible a flat surface for installation. Don't use excessive force when tightening screws, or lower part might get deformed.

### 4. Connecting method as the following chart

| No | Symbol | colour         | contents |
|----|--------|----------------|----------|
| 1  | A      | White or Green | 12V      |
| 2  | B      | Red            | Gnd      |
| 3  | C      | Yellow         | COM      |
| 4  | D      |                |          |

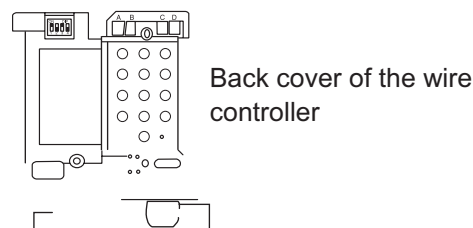

- Use shielded wires for telecommunication between wire controller and indoor unit; indoor unit and outdoor unit. Ground the shield on one side.
- Otherwise misoperation because of noise may occur.
- Signal wire is self-provided by user.

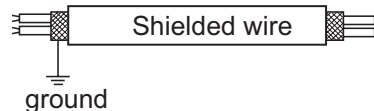

### 5. Replace the upper cover of wire controller

Be careful not to hold down the wiring.

**Hint** 1. Power supply switch and signal wire should be prepared by the user.

2. Don't touch PCB with hand.

### 7.1 Remote controller YR-H71

If the unit is wired type and it is without the remote receiver, you can use the remote receiver RE-01 and the remote controller YR-H71 to realize the remote function. The installation of remote receiver and usage function are as follows:

The right figure is a remote controller, which can be used on series remote control units and the matching remote control receiver

1. Remote control receiver using method :

Use remote controller control the remote control window of the remote control receiver.

**2. Series remote controller units**

**please press the button "CODE" to choose the program of code "B"**

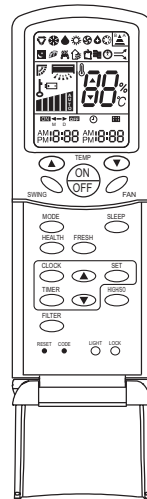
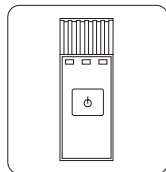
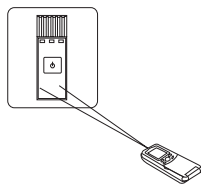

Remote receiver Remote controller

#### Installation of receive display

Because of the temperature sensitive device, do not install the receive display at straight sunlight place, either in front of air outlet grill, for it is effected greatly from cool air and heat air, the receive display is at least 20mm distance to the air outlet grill.

Since there is light sensitive device which receives wireless remote signal, so do not installed behind the window curtain or other obstacles, in order not to obstruct the signal.

Must fix the remote control wire far from strong electricity (such as the wiring of electric light, air conditioner, etc.) and weak electricity (such as the wiring of telephone, interphone, etc.).

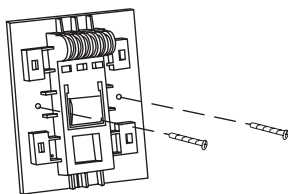

1. Fix the receive display with screws on the selected place

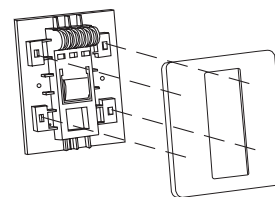

2. Place the panel onto the fixed frame, pay attention that the four claws must be placed into the corresponding four poles on the frame

Connecting wiring method of receiver :

Refer the indoor unit wiring diagram .

Safety cautions see the electrical wiring part .

- ①. Emergency switch
- ②. Running lamp: When the compressor working, this lamp bright.
- ③. Timing lamp: When the unit been setting Timing running, this lamp bright.
- ④. Power lamp: After open the unit, this lamp bright when the unite enter health running, the lamp change from orange to blue lamp.
- ⑤. Indoor temp. sensor: Test the room temperature.

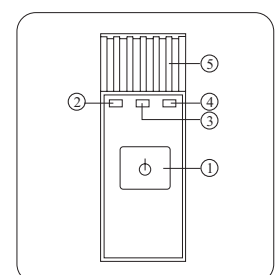

### 8. Refrigerant Diagram

HBU-18CF03

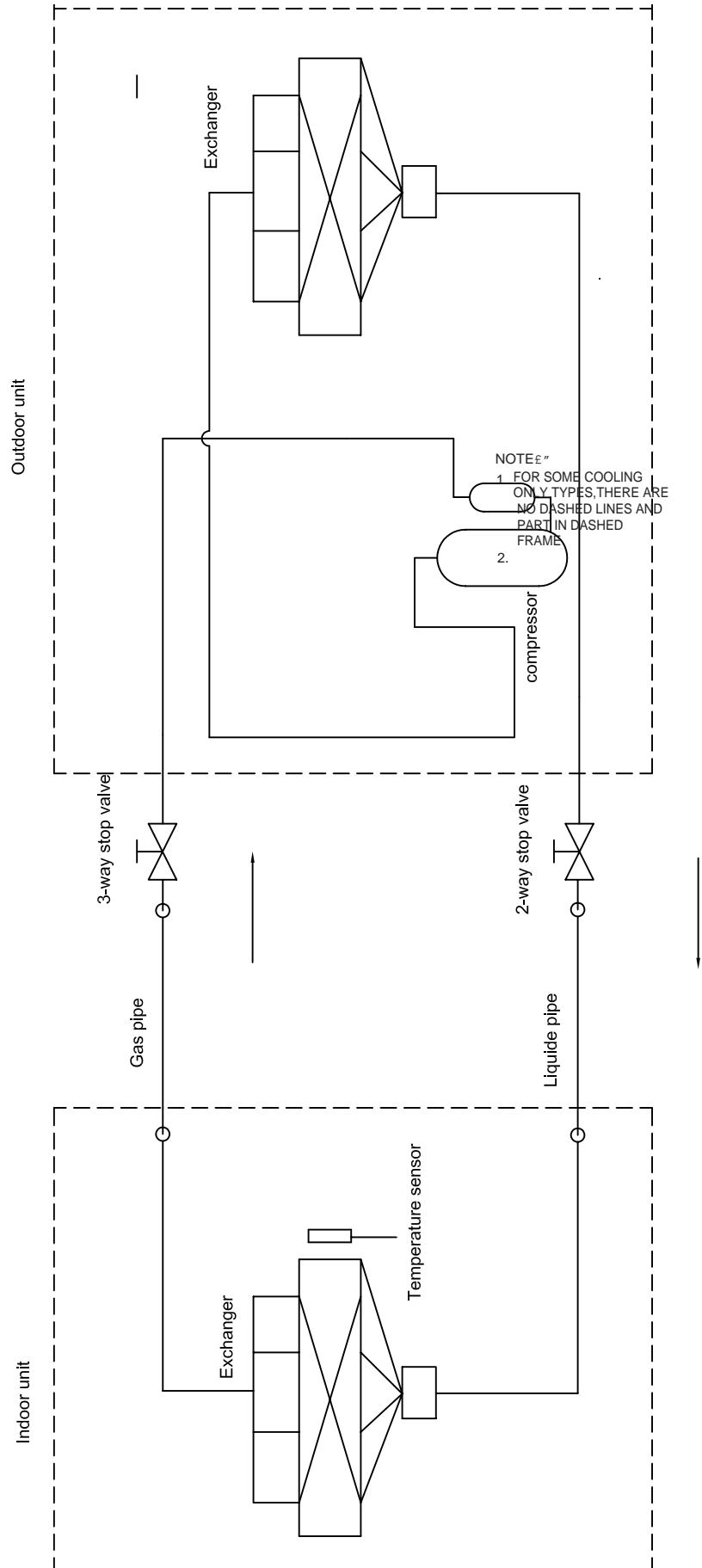

HDU-42CF03/H

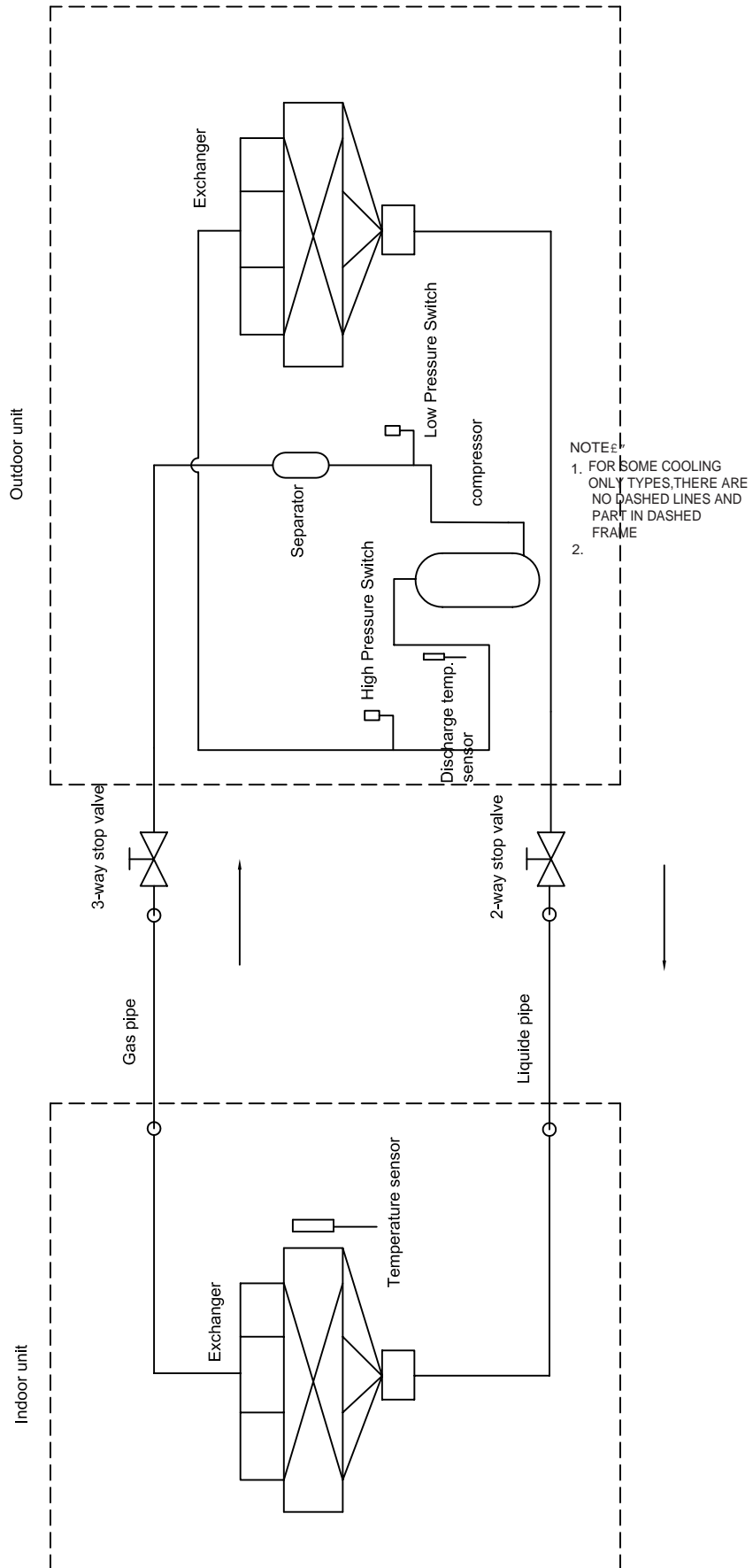

HPU-42HF03

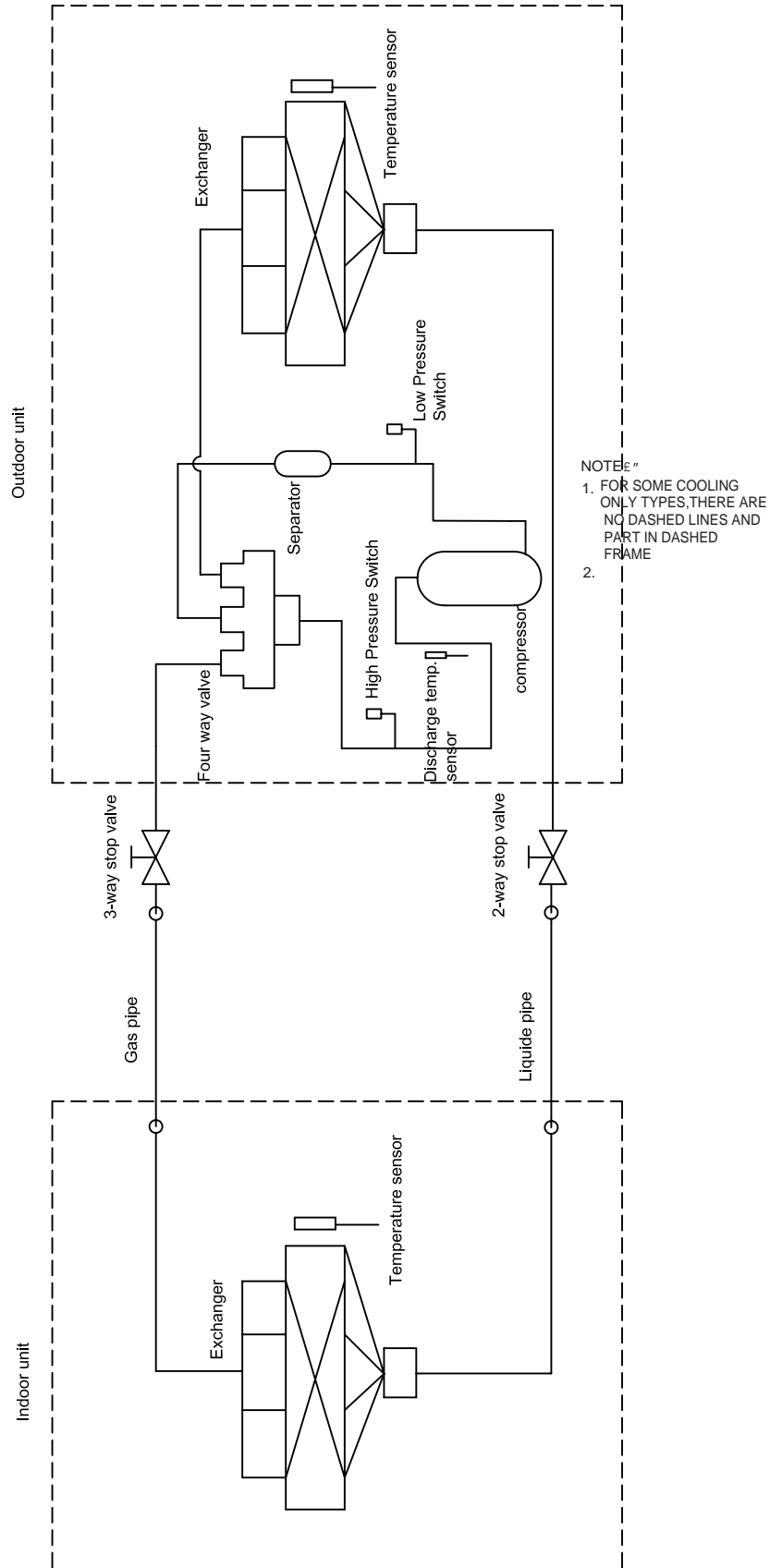

### 9. Electrical Control Functions

#### 9.1 Control Features

The brief introduction includes those for each item of various types of air conditioners and their electric control functions.

##### 7.1 Brief introduction of electric control

###### (1) Automatic run

###### a. Cooling-heating type

After the machine being started and running mode changes to AUTO, the system will decide running mode according to difference between the present room temperature and setting temperature, then runs as the decided mode. In the following selections, Tr means room temperature and Ts means setting temperature.

Select running mode according to the following conditions at the first time to enter Auto mode:

- $Tr \geq Ts - 3^{\circ}\text{C}$  to select cooling mode (with setting temperature being  $Ts + 3$ )
- $Tr < Ts - 3^{\circ}\text{C}$  to select heating mode (with setting temperature being  $Ts$ )

After the system entering auto run mode, the running mode can convert automatically according to variation of room temperature between cooling, blowing and heating in the way shown as the chart below:

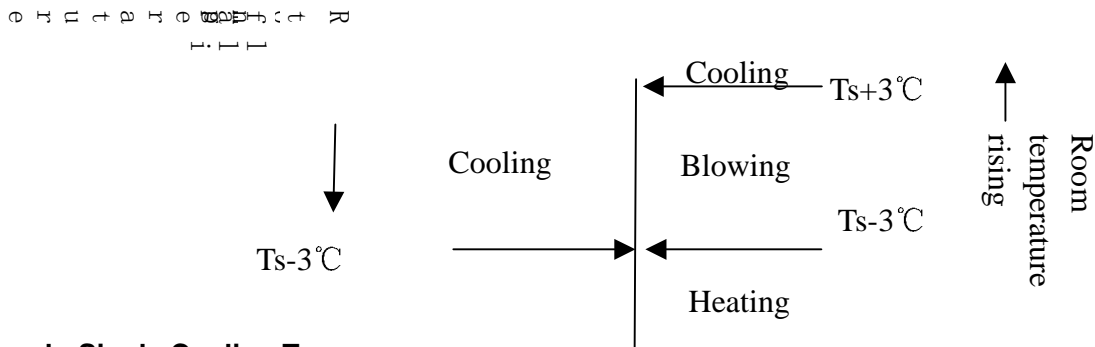

###### b. Single Cooling Type

Select running mode according to the following conditions at the first time to enter Auto mode:

- $Tr \geq Ts + 3^{\circ}\text{C}$  to select cooling mode
- $Tr < Ts + 3^{\circ}\text{C}$  to select blowing mode

After the system entering auto run, the running mode can convert automatically according to variation of room temperature between cooling and blowing functions in the way shown as the chart below:

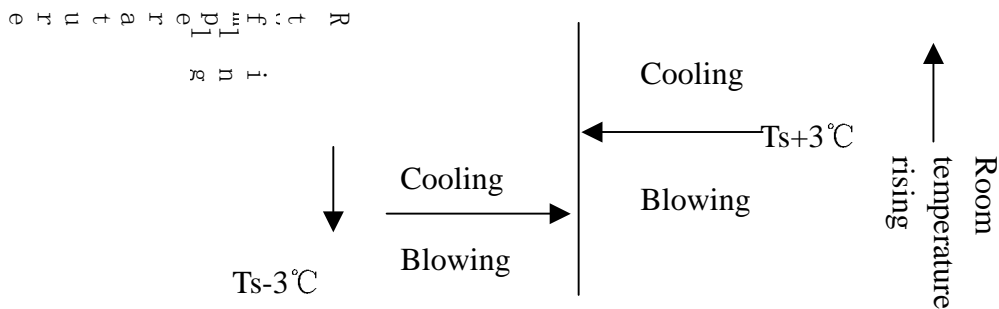



### (2) Auto Selection of Wind Speed

In the following,  $T_r$  means room temperature while  $T_s$  means setting temperature.

**a. During cooling program**, conversion of wind speed from the low to high won't work until the present speed has continued for 3 minutes while conversion from the high to low needs no time delay. The chart below is the sketch map of conversion:

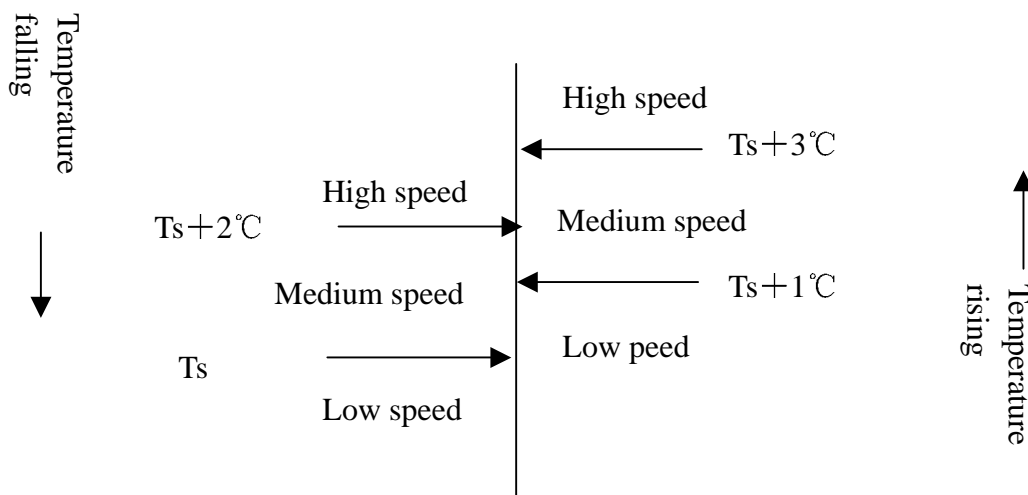

**b. During heating program** (applicable for cooling-heating type), conversion of wind speed from the low to high won't work until the present speed has continued for 3 minutes while conversion from the high to low needs no time delay. The chart below is the sketch map of conversion:

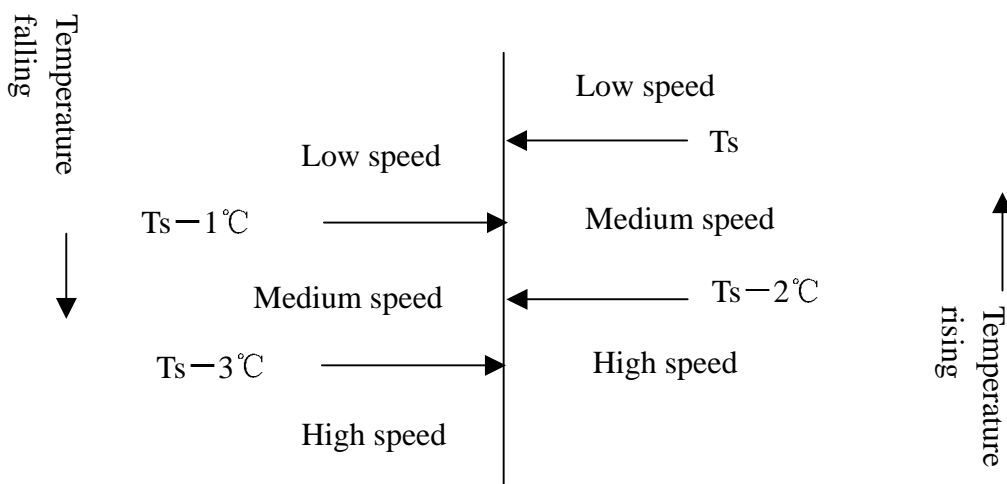

### (3) Dehumidifying program

In the following,  $T_r$  means room temperature while  $T_s$  means setting temperature.

a. After the system entering dehumidifying program, the compressor, outdoor and indoor blowing fans run according to the following rules:

(1)  $T_r > T_s + 2^\circ\text{C}$ , the compressor and outdoor blowing fan run continuously while indoor

blowing fan runs at setting wind speed. This working area is defined as area A.

- (2)  $T_s \leq T_r \leq T_s + 2^\circ\text{C}$ , the compressor and outdoor blowing fan run for 10 minutes then pause for 6 minutes, while indoor blowing fan runs at low wind speed. This working area is defined as area B.
- (3)  $T_r < T_s$ , the compressor and outdoor blowing fan stop working while outdoor blowing fan runs at low wind speed. This working area is defined as area C.

a. After dehumidifying program starting, the system converts between A, B and C areas according to variations of room temperature with running mode being shown as the chart below:

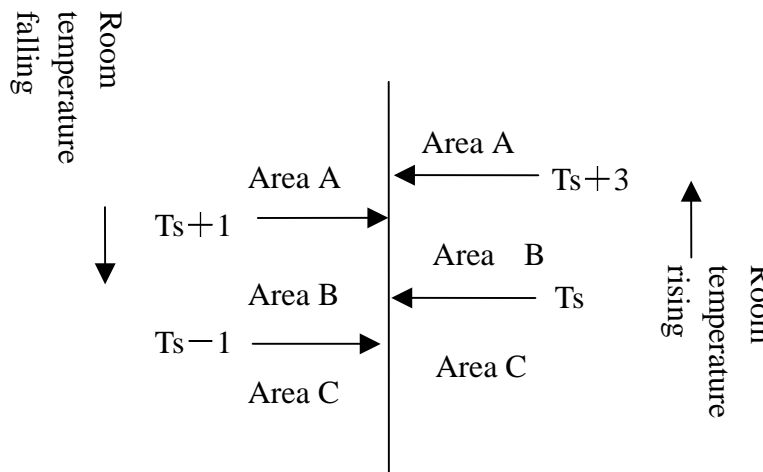

#### (4) Cutoff protection against overload and overheat

During heating program, if the indoor blowing fan has been started and the compressor has been running more than 2 minutes, and the **temperature of indoor coil pipe (Ticp)**  $> 64^\circ\text{C}$ , the outdoor blowing fan will stop running; If  $Ticp \leq 50^\circ\text{C}$  and the outdoor blowing fan has kept stop state for 45 seconds, then it will restore rotation; If  $Ticp > 67^\circ\text{C}$  and such temperature has last for 10 seconds, the compressor will stop running and indoor blowing fan run according to conditions as it reaches setting temperature. When  $Ticp < 58^\circ\text{C}$ , and the compressor has kept stop state over 3 minutes, then the compressor and outdoor blowing fan will restore normal running.

#### Cutoff protection for heating current

After 60 seconds from the compressor being started, if CT current exceeds I1 (9.2A) and such case has kept 5 seconds, the outdoor blowing fan will stop. If 45 seconds has passed after the outdoor blowing stops and the current of the compressor is less than I2 (7.5A), the blowing fan will restore running. If CT current exceeds I3 (14.3A) and such case lasts for 3 seconds, the compressor and outdoor blowing fan will stop. The compressor will not restore running until 3 minutes passes with CT current less than 12A.

#### (5) Cool wind prevention during heating program

At the first time entering heating program or after ending the latest frost removal, if the **temperature of indoor coil pipe (Ticp)**  $< 28^\circ\text{C}$ , the indoor blowing fan will stop running; If  $28^\circ\text{C} \leq Ticp < 38^\circ\text{C}$ , the indoor blowing fan will run at low speed; If  $Ticp > 38^\circ\text{C}$  or the compressor has been running for more than 4 minutes, the indoor blowing fan will run at

setting wind speed.

(6) Afterheat blowing during heating program

During heating program, the compressor will stop running (except overheat protection or frost removal) while the indoor blowing fan will firstly run for 50 seconds at low speed then stop.

(7) Frost removal control (applicable for cooling-heating type)

(1) Starting conditions for frost removal:

- A. The indoor unit is in overload protection and outdoor blowing fan stops. The outdoor blowing fan does not enter overheat mode in 10 minutes after it is restarted, the compressor has run over 45 minutes totally while 20 minutes continuously, and the temperature of indoor coil pipe is lower than 43°C;
- B. After the compressor continuously running for 20 minutes, the temperature of indoor coil pipe falls 1°C every 6 minutes and such case continuously appears three times, and the temperature of indoor coil pipe is less than 40°C, and 5 minutes have passed after the compressor is restarted;
- C. The compressor has run totally over 3 hours while 20 minutes continuously, and the temperature of indoor coil pipe is less than 40°C;
- D. The difference between room temperature and the one of indoor coil pipe is less than 16°C and the compressor has totally run over 45 minutes while 20 minutes continuously;

Frost removal will start if any one of the above conditions is satisfied.

(2) Ending conditions for frost removal:

- 1) Time of frost removal has exceeded 9 minutes;
- 2) CT current exceeds I4(8.2A);

(3) Actions of each load after the frost removal starts:

The compressor and outdoor blowing fan stop, and indoor blowing fan also stops. 55 seconds later the reversal valve is closed and next 5 seconds later the compressor is started.

(4) Actions of each load after the frost removal ends:

The compressor stops running while outdoor blowing fan immediately runs at high speed, 55 seconds later the reversal valve is opened and next 5 seconds later the compressor restores running and indoor blowing fan runs as conditions for cool wind prevention.

(8) Freeze protection

After the compressor has run for 9 minutes, the system will check **temperature of indoor coil pipe (Ticp)**. If Ticp is less than -1°C, the compressor and outdoor blowing fan will stop. They will run again after the compressor stops if both the following conditions are satisfied:

- 1) 3 minutes have passed since compressor stops.
- 2) Ticp exceeds 7°C.

(9) 3 minutes protection for compressor

After compressor stops, it cannot be started until 3 minutes later. During the machine's running, if time after losing power not exceeds 3 minutes, the compressor cannot be

restarted until 3 minutes later after it is reenergized.

(10) Power breakdown memory

If the machine suddenly loses power while running, or stops for maintenance or trouble shooting, it will restart running as the status when it stops after the power is restored.

- Note: 1. Function setting: Continuously press sleep button on the remote controller 10 times in 5 seconds and buzzer on control panel shall beep 4 times.
2. Memory content: Running mode, wind speed setting, temperature setting, swing status.
  3. Cancel: Press sleep button on the remote controller 10 times and buzzer on control panel beeps 2 times.

(11) Control of water pump

- a. In cooling (including automatic cooling mode) and dehumidifying modes, the water pump works if the compressor runs while stops 5 minutes later after the compressor stops.
- b. When water tank is fully filled, the float switch will be off. The water pump will start to work after a controller has detected this signal and it will continue working for 5 minutes after the float restores to normal state.
- c. If the full water signal is detected continuously over 5 minutes, the water pump indicator lamp will flash to alarm and compressor stops running. The water pump will run 5 minutes, then pause for 5 seconds before next 5 minutes' running, ... until the float restores to normal state, after which the pump will run for 5 minutes then stop.

(12) Monitoring of remote network

Through preset interface, the air conditioner is connected to remote control detector (made by Haier) with 2-core cables for wire communication, to execute instructions sent from computer or centralized controller via remote control detector and meanwhile send present running status and trouble information of the machine to remote control detector. Connection between air conditioner and remote control detector:

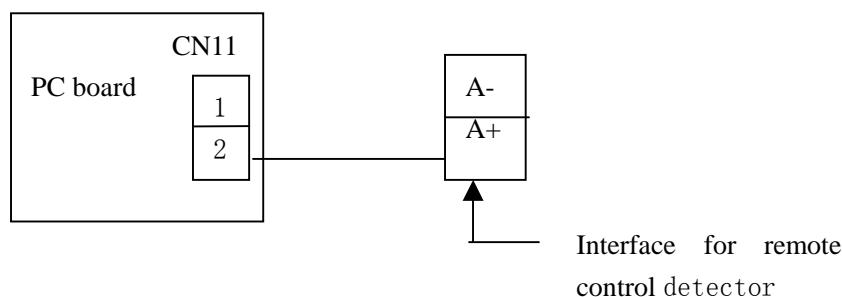

(13) Trial run

Under shut-down state, hold pressing mandatory button. The buzzer will beep once, then twice after 5 seconds. Release the button to enter mandatory cooling mode, under which the indoor blowing fan runs at high speed with both the compressor and outdoor blowing fan working. Press the mandatory button again can end the mandatory mode.

### 9.2 Defrost operation flow chart

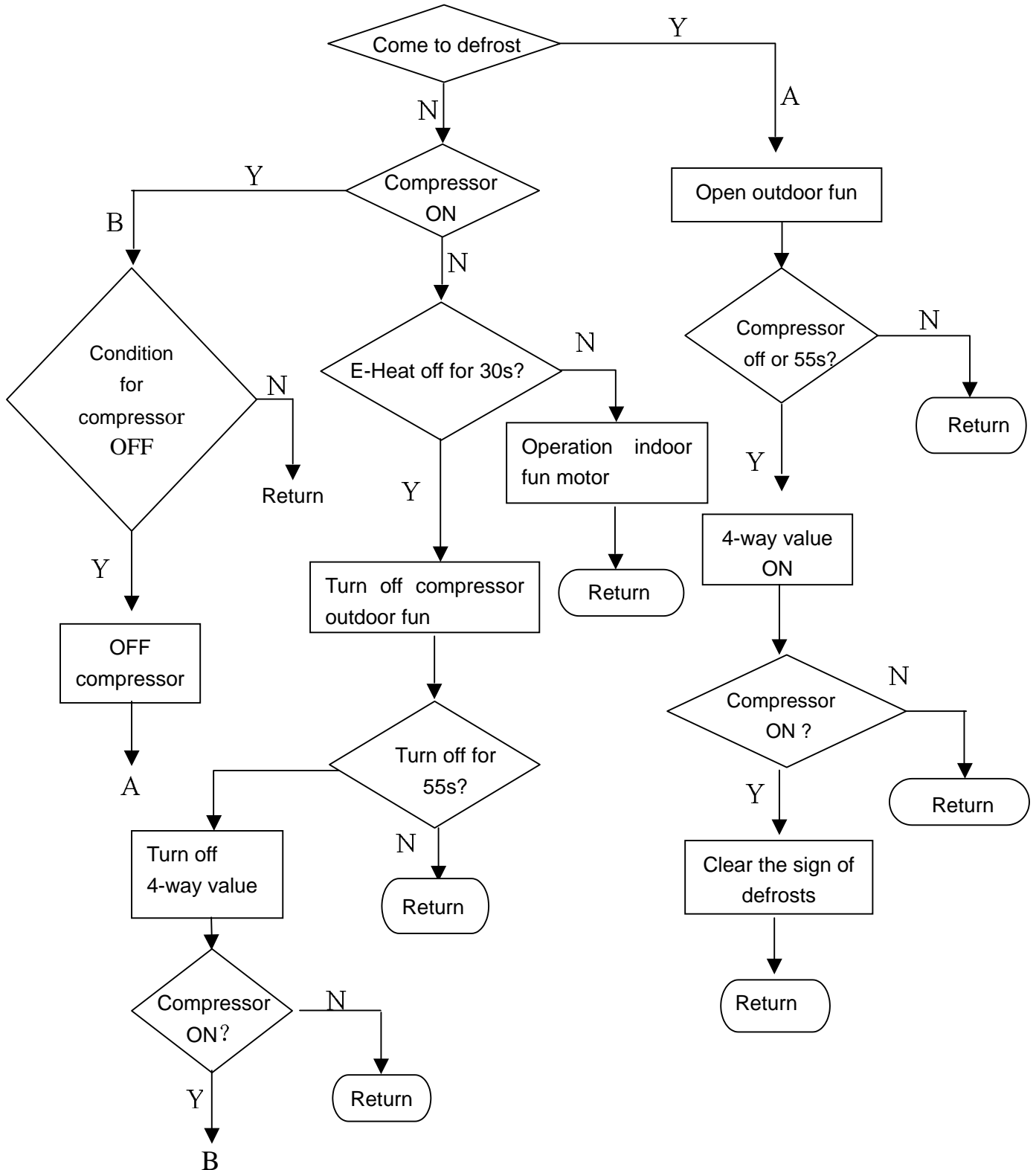

### 10. Diagnostic information (troubleshooting)

#### 10.1 System failure

If the refrigerant in the system cannot flow fluently or the airflow circles more slowly, please check due to the following procedures.

Cooling:

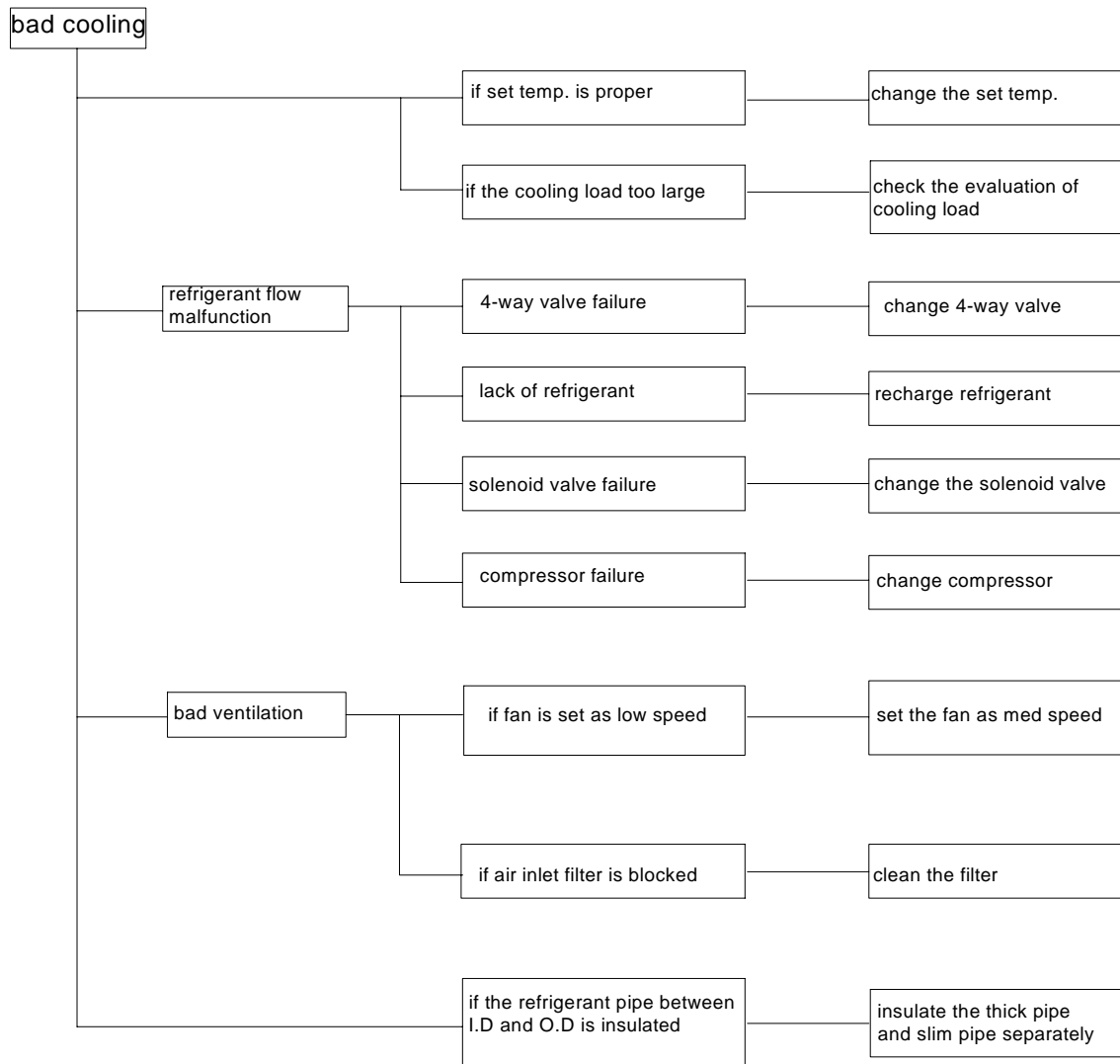

Figure 1

## 10.2 Failure code

The remote receiver, wired controller and indoor PCB indicator all can indicate the failure code.

## 10.2.1 Failure code list

| Power lamp flash times/LED on PCB flash times | failure description                                 | reasons   | treatment                   |
|---|---|---|-----------------------------|
| 1   | Indoor ambient temp. sensor failure                 | sensor broken down or short circuit for more than 2m continuously | due to the signal,resumable |
| 2   | Indoor pipe temp. sensor failure                    | sensor broken down or short circuit for more than 2m continuously | due to the signal,resumable |
| 4   | Outdoor pipe temp. sensor failure                   | sensor broken down or short circuit for more than 2m continuously | due to the signal,resumable |
| 8   | Communication failure between panel and indoor unit | communication abnormal for more than 4m continuously              | due to the signal,resumable |
| 16  | Low pressure malfunction                            | low pressure switch acts for 30m                                  | Need to be checked, reset   |

## 10.2.2 Sensor malfunction

If indoor ambient temp. sensor and indoor pipe temp. sensor are valid, there is no outdoor sensor, in the following conditions, the unit will confirm the sensor is failure:

Mainboard checks that the sensor is in open circuit, short circuit or close to short circuit continuously for 2 minutes, the mainboard will confirm that sensor is failure, the system will stop running, alarm occurs; If the signal is resumed, the system will resume automatically.

If indoor ambient temp. sensor and indoor pipe temp. sensor is valid, also there is outdoor sensor, in the following conditions, the unit will confirm the sensor is failure:

Mainboard checks that the outdoor pipe temp. sensor is in open circuit, short circuit or close to short circuit continuously for 2 minutes, the mainboard will confirm that sensor is failure, the system will stop running, alarm occurs; If the signal is resumed, the system will resume automatically.

Diagnose and troubleshooting:

### 1) Sensor failure

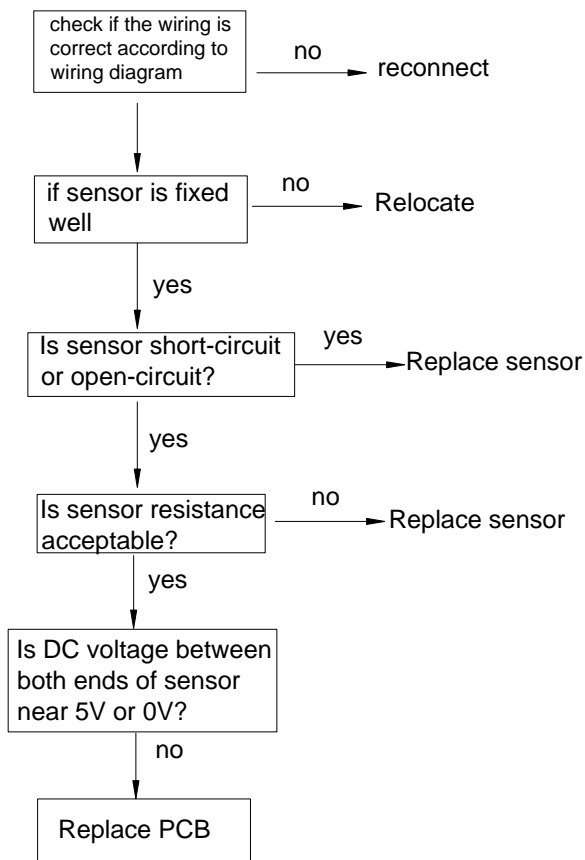

### 2) Communication failure between operation panel and indoor unit

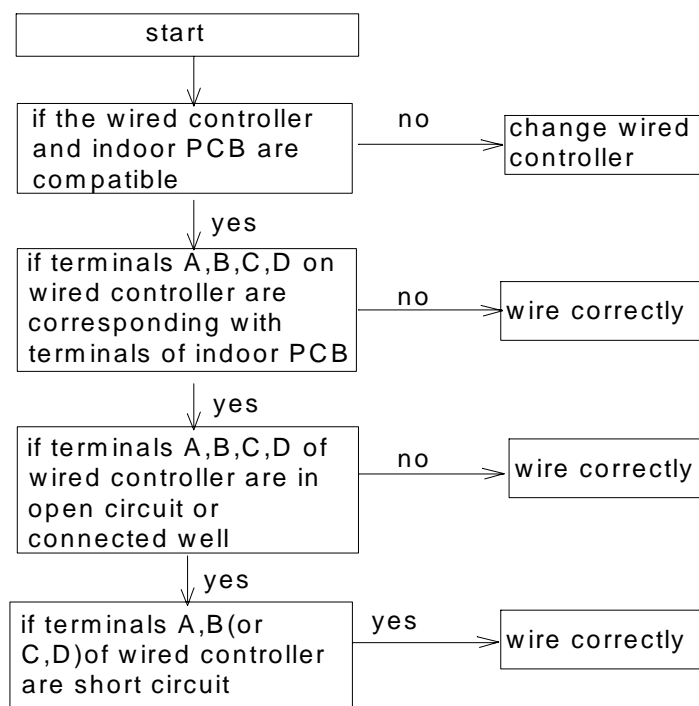



## 3) Low pressure abnormal

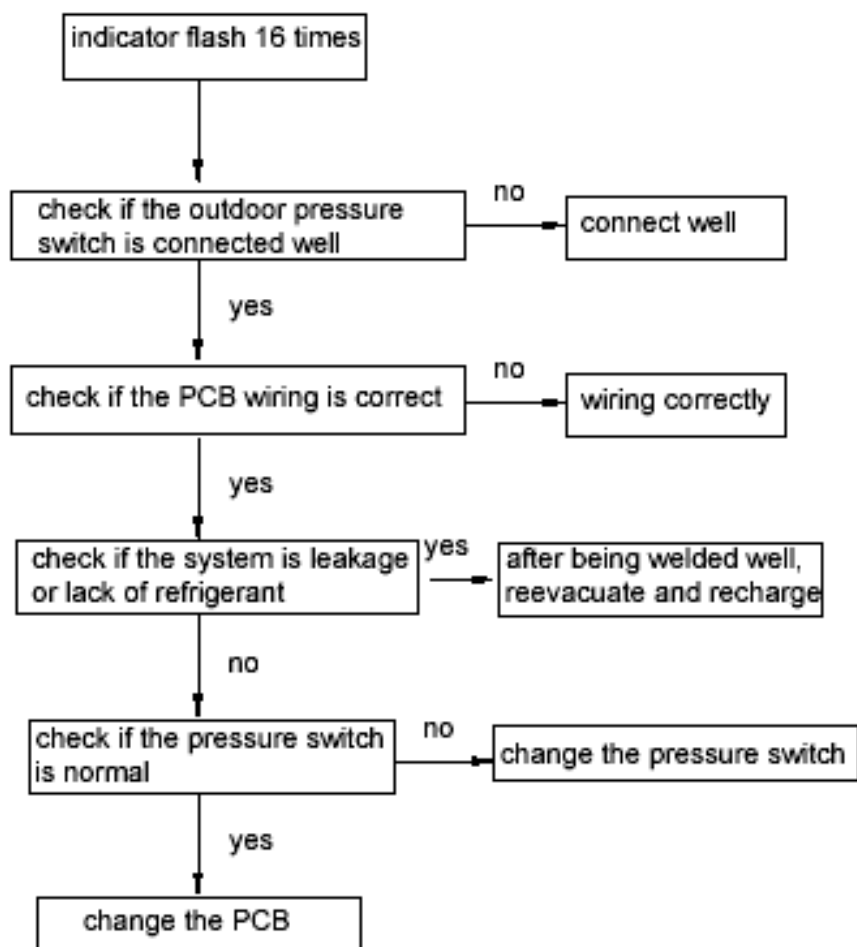

If there is other failure, please check if the dip switch is correct.

### 11. Electric data

#### 11.1 Wiring diagram

HBU-18CF03

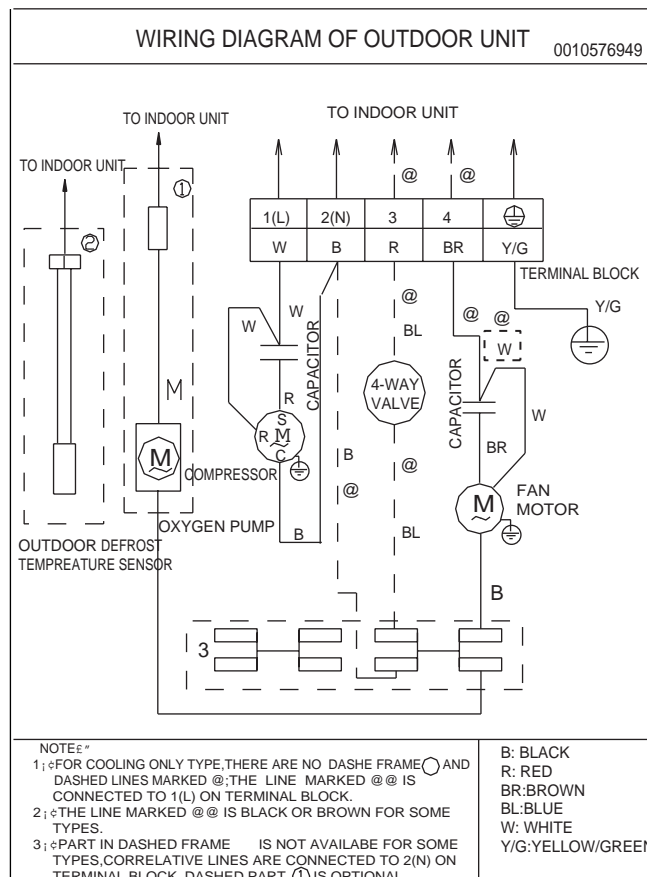
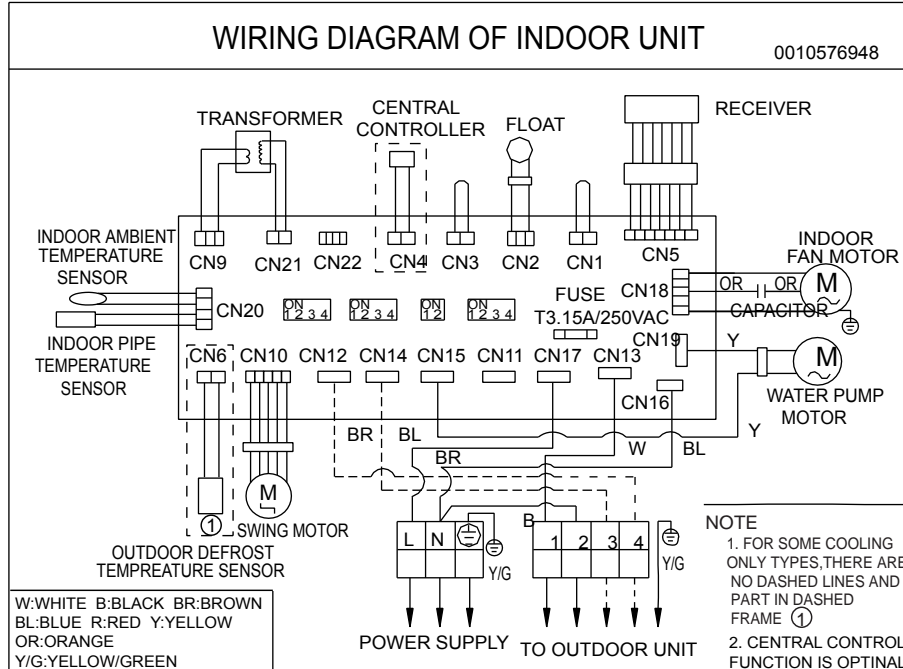

### HDU-42CF03/H

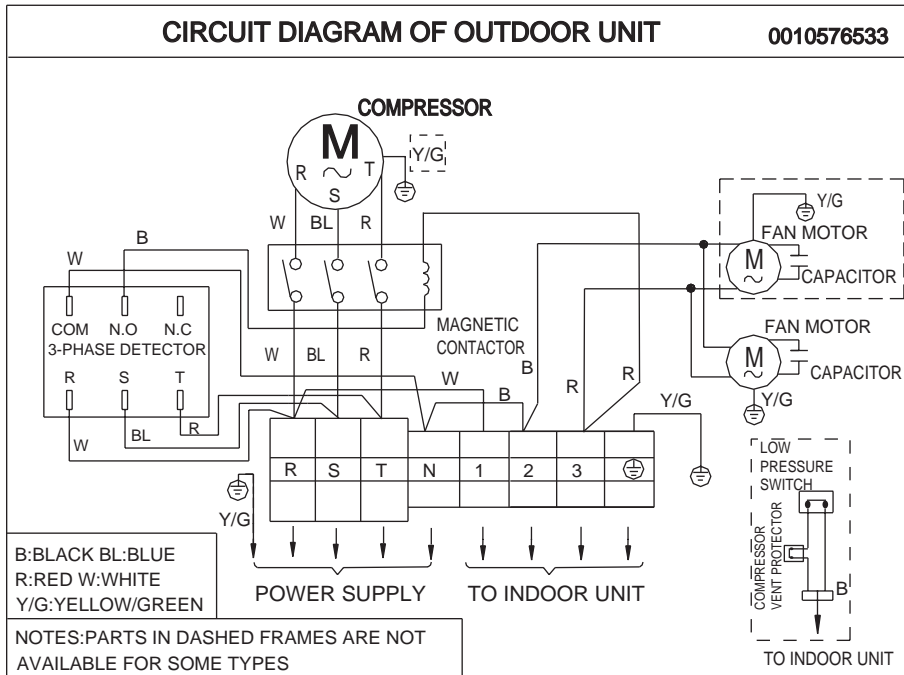
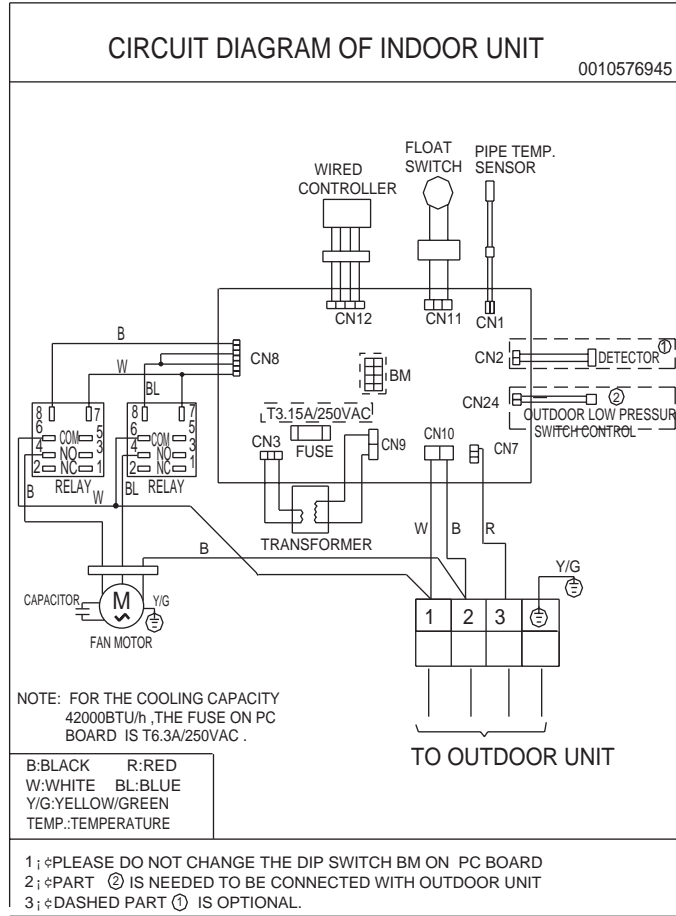

### HPU-42HF03

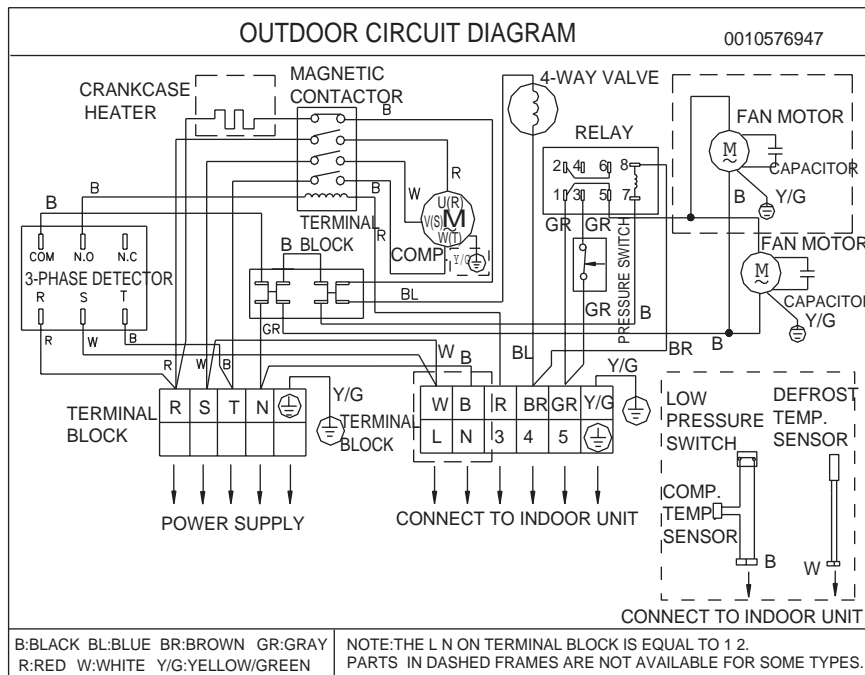
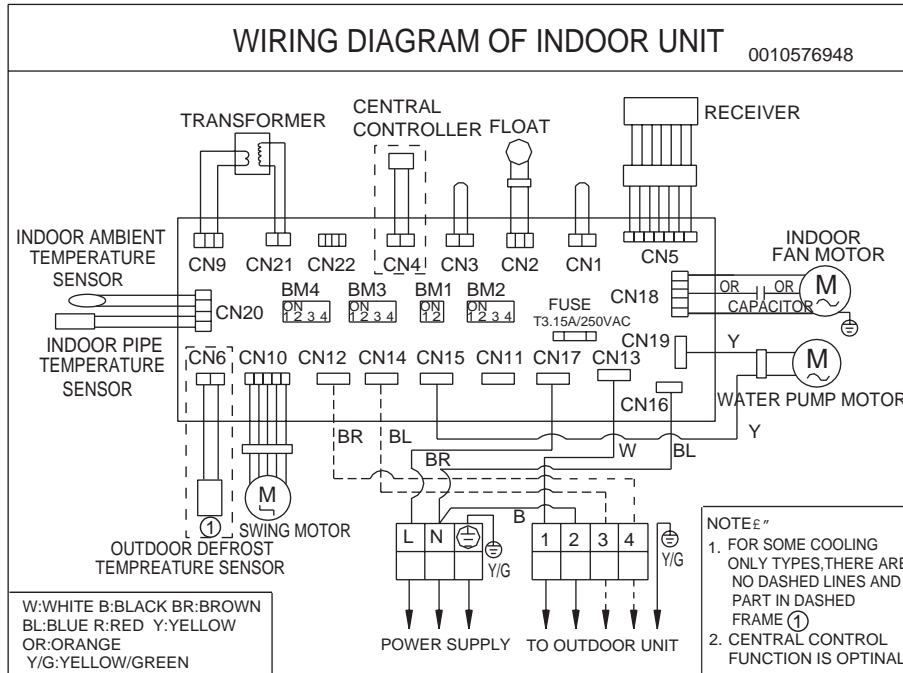

### 11.2 Circuit diagram

#### HBU-18CF03

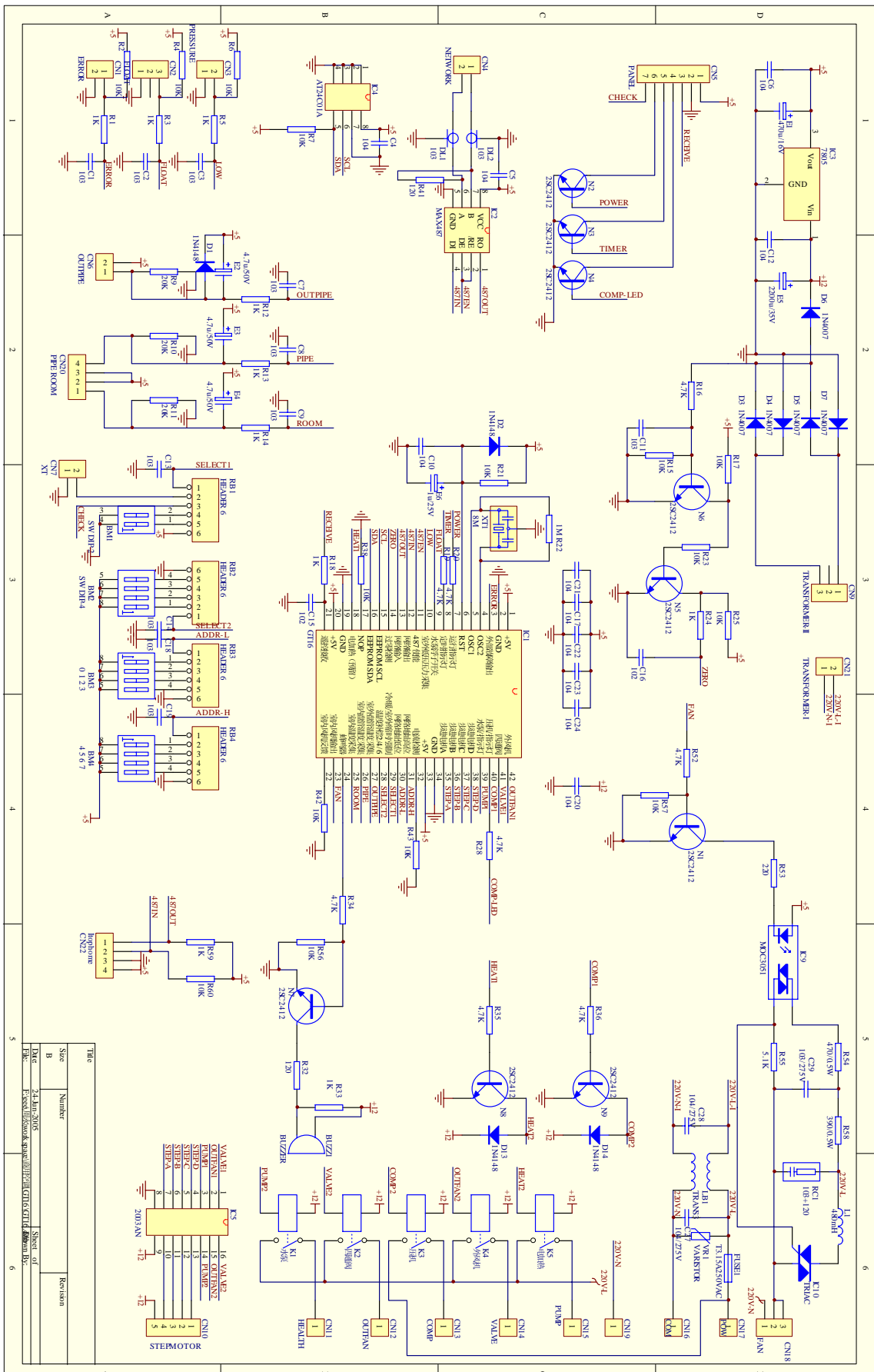

### HDU-42CF03/H

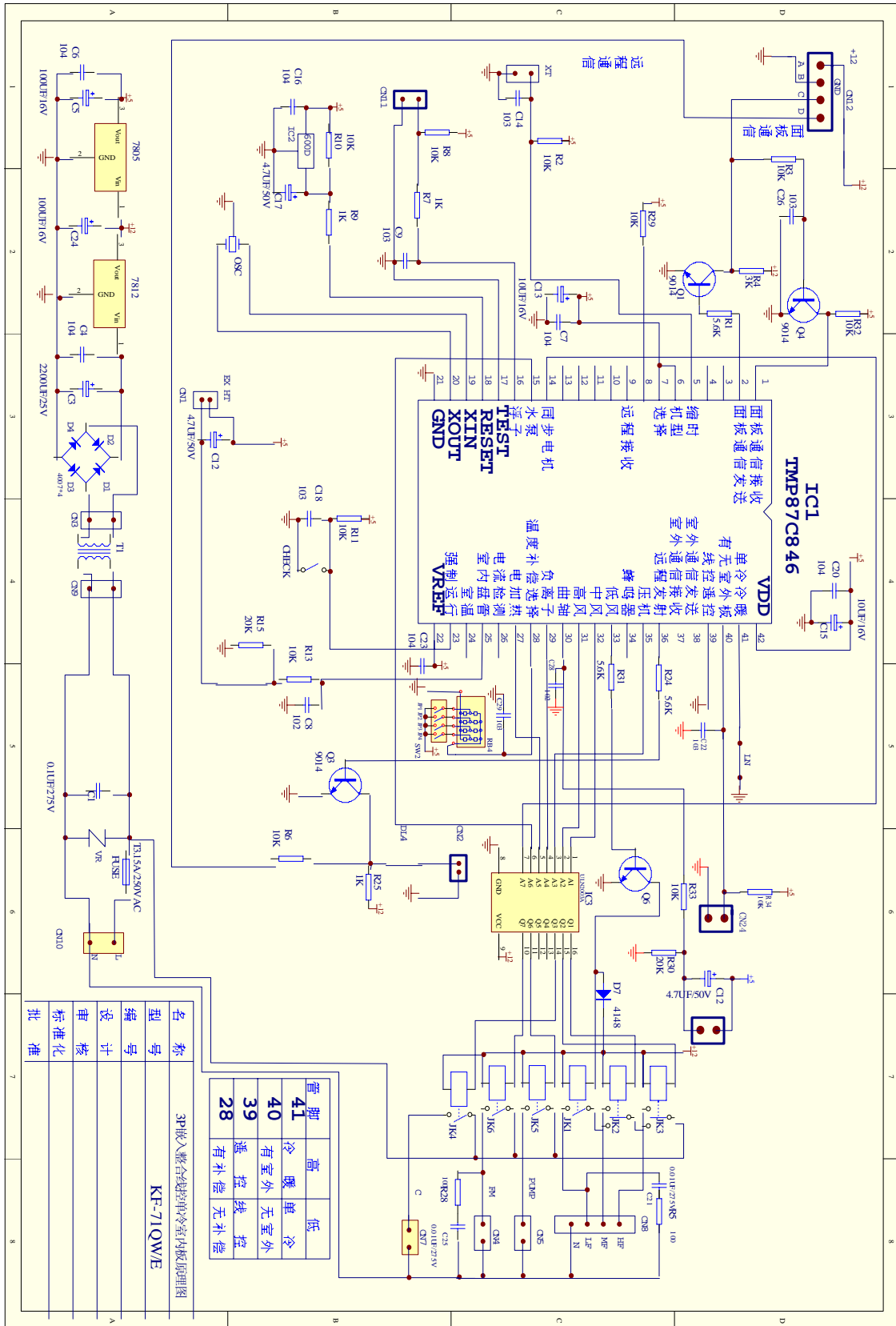



# Commercial Air Conditioner

Model: HBU-18CF03  
HDU-42CF03/H HPU-42HF03

## HPU-42HF03

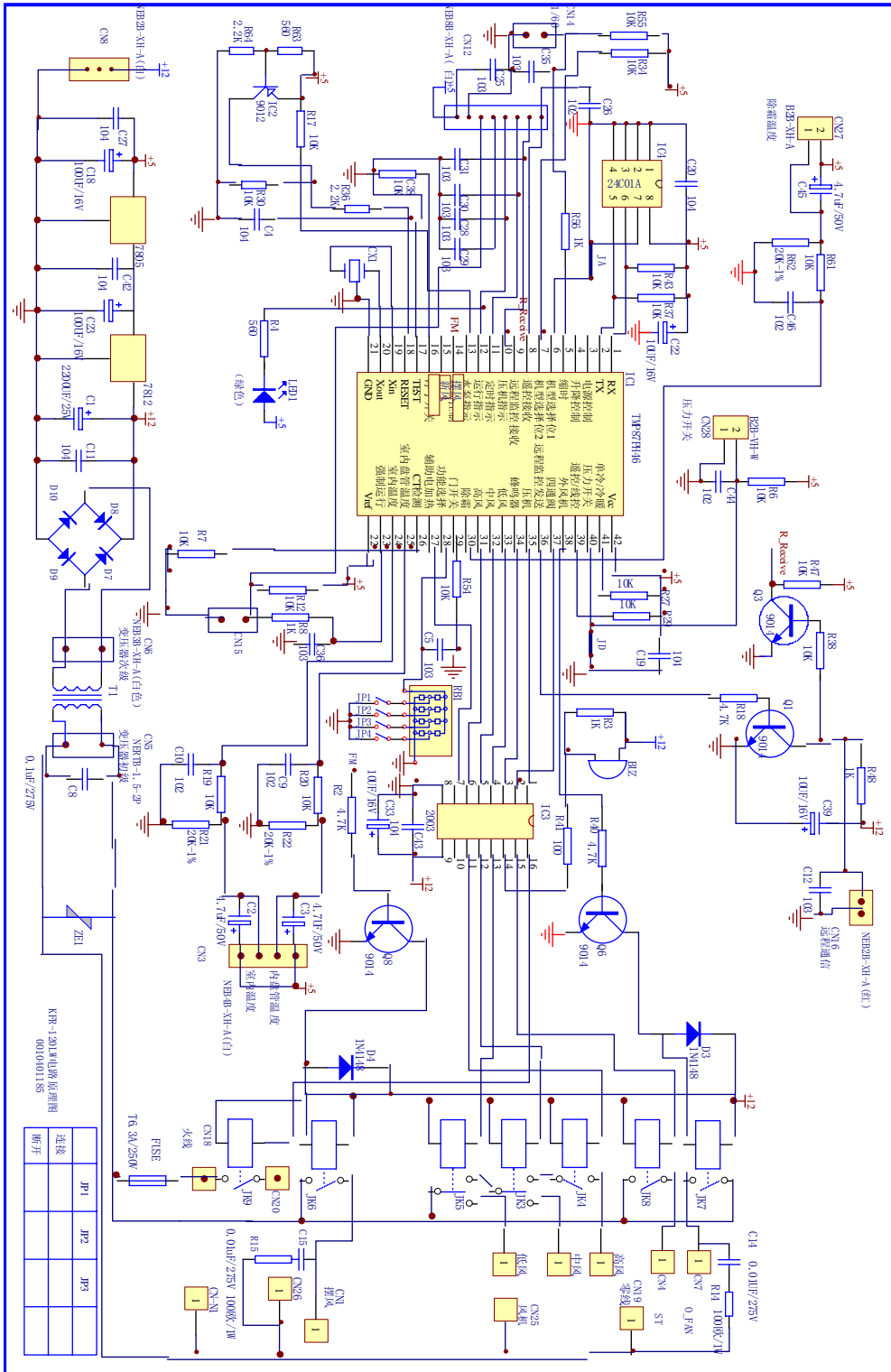

### 11.3 Printed diagram

HBU-18CF03

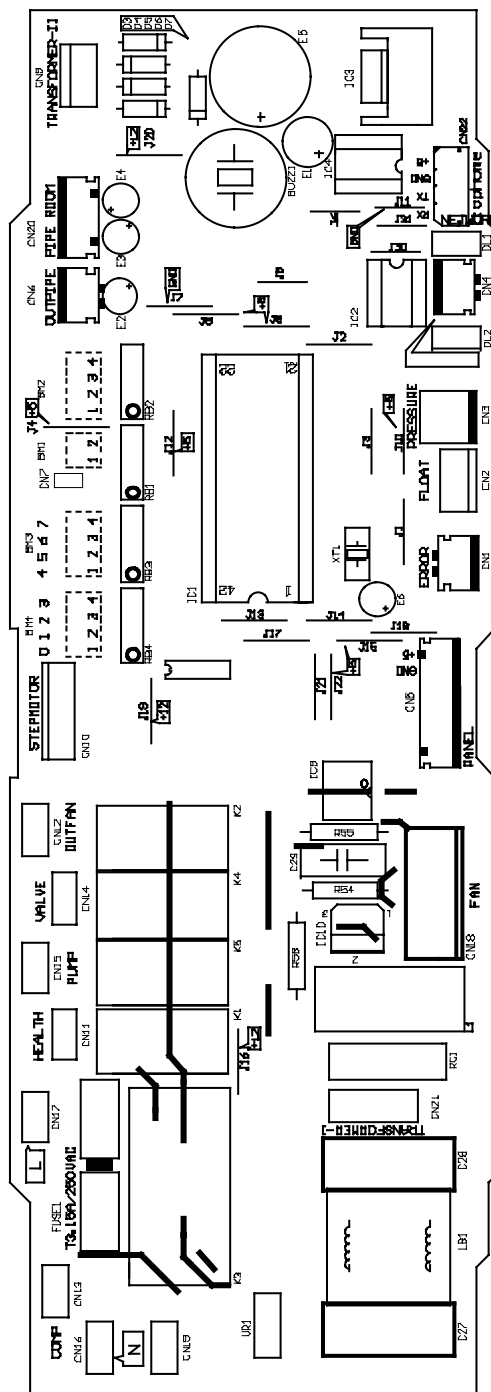

#### Port and definition

- CN1: external alarm input
- CN2: control port of float switch
- CN3: control port of low pressure switch
- CN4: central control port
- CN5: remote receiver panel
- CN6: outdoor deforst



- CN7: time-shrink port
- CN9: output port of transformer
- CN10: swing motor port
- CN11: reserved port
- CN12: outdoor fan motor port
- CN13: compressor port
- CN14: control port of 4-way valve
- CN15: water pump port
- CN16: neutral wire port
- CN17: live wire port
- CN18: fan motor port
- CN19: neutral wire port
- CN20: indoor coil temp. sensor  
indoor ambient temp. sensor
- CN21: input port of transformer
- CN22: control port of network appliance

| Dip switch state | BM1 (1) | BM1 (2) |   | Remark     |
|------------------|---------|---------|---|------------|
| No outdoor PCB   | ×       | ×       | The PCB of this type have not outdoor PCB | OFF-× ON-√ |
| Unitary free     | √       | ×       |   |            |
| Free multi       | ×       | √       |   |            |
| Unitary inverter | √       | √       |   |            |

| Dip switch state                 | BM2(1) | BM2(2) | BM2(3) | BM2(4) |
|----------------------------------|--------|--------|--------|--------|
| No temperature compensation      | ×      | ×      | *      | *      |
| Temperature compensation 2°C     | √      | ×      | *      | *      |
| Temperature compensation 4°C     | ×      | √      | *      | *      |
| Temperature compensation 6°C     | √      | √      | *      | *      |
| Cooling only/heating and cooling | *      | *      | √/×    | *      |
| Have/no defrost sensor           | *      | *      | *      | √/×    |

BM3、BM4: set address when used central control

| Address | BM4 |       |       |       | BM3   |       |       |       |                            |
|---------|-----|-------|-------|-------|-------|-------|-------|-------|----------------------------|
|         | 1   | 2     | 3     | 4     | 1     | 2     | 3     | 4     |                            |
| 1       | ×   | ×     | ×     | ×     | ×     | ×     | ×     | ×     | × - no network appliance   |
| 2       | √   | ×     | ×     | ×     | ×     | ×     | ×     | ×     |                            |
| 3       | ×   | √     | ×     | ×     | ×     | ×     | ×     | ×     |                            |
| 4       | √   | √     | ×     | ×     | ×     | ×     | ×     | ×     |                            |
| 5       | ×   | ×     | √     | ×     | ×     | ×     | ×     | ×     | √ - have network appliance |
| 6       | √   | ×     | √     | ×     | ×     | ×     | ×     | ×     |                            |
| .....   |     | ..... | ..... | ..... | ..... | ..... | ..... | ..... |                            |
| 126     | √   | ×     | √     | √     | √     | √     | √     | √     |                            |
| 127     | ×   | √     | √     | √     | √     | √     | √     | √     |                            |
| 128     | √   | √     | √     | √     | √     | √     | √     | √     |                            |

HDU-42CF03/H

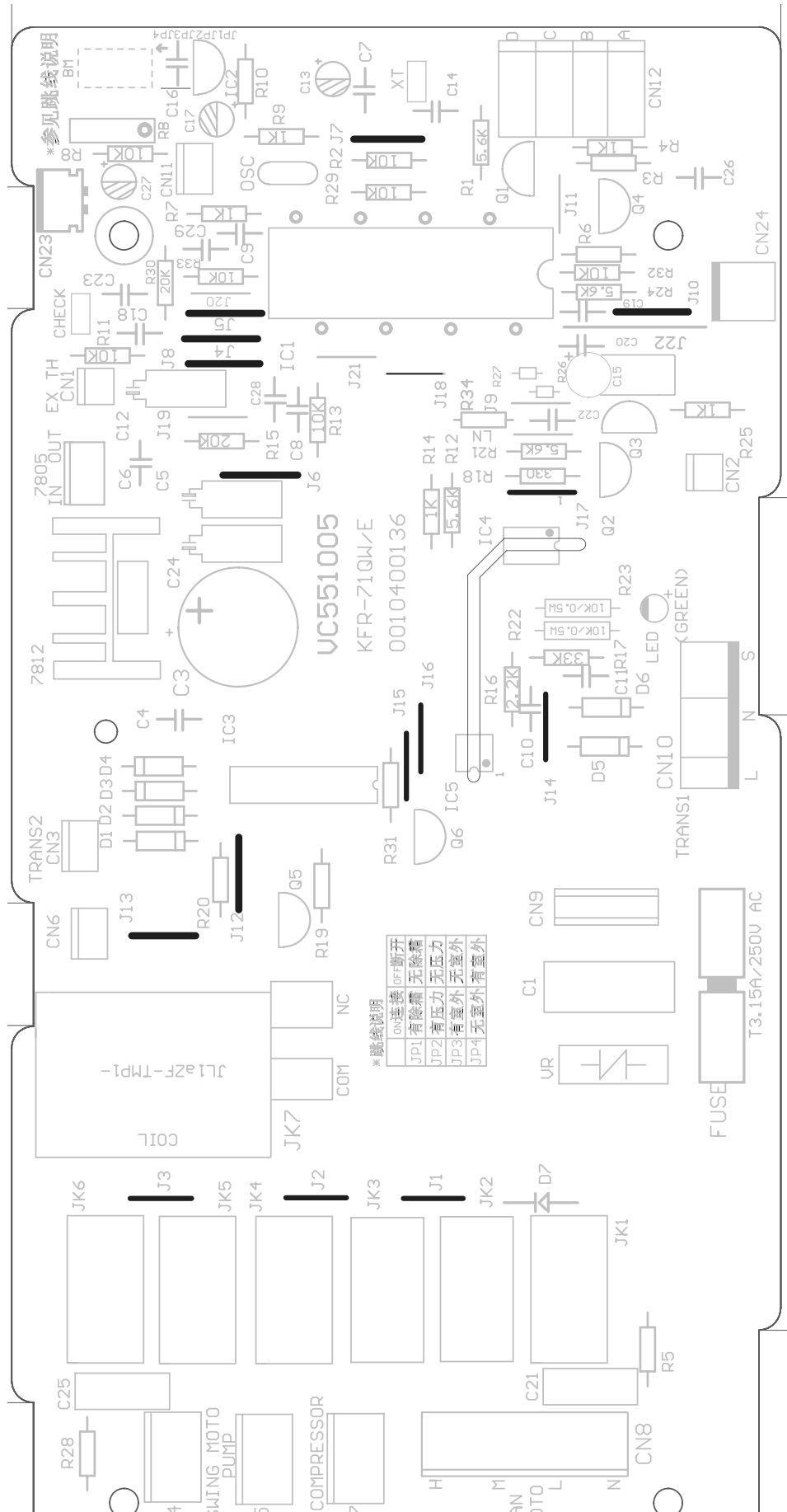

### Port and definition

CN1: indoor coil temperature sensor

CN2: connection port of detector

CN3: output port of transformer

CN4: swing port

CN5: water pump port

CN7: control port of outdoor compressor and fan motor

CN8: indoor fan motor port

CN9: input port of transformer

CN10: power input port of PCB

CN11: float switch

CN12: wired controller port

CN23: connection port of outdoor defrost sensor

CN24: control port of outdoor low pressure switch

HPU-42HF03

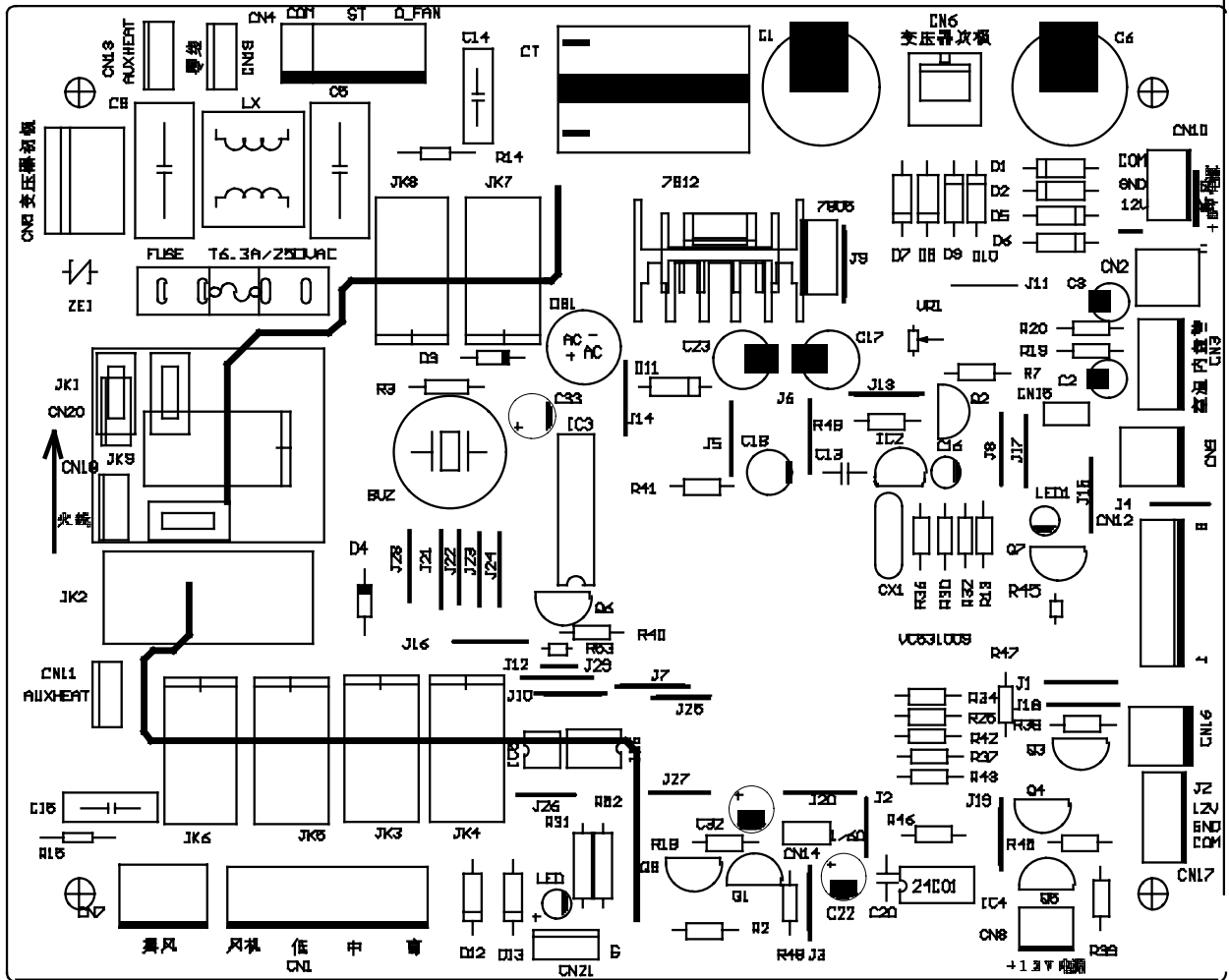

Port and definition:

- CN1: control port of live wire of swing motor
- CN3: signal input port of ambient temp. sensor ,coil temp. sensor
- CN4: control port of 4-way valve ( not available for cooling only type )
- CN5: primary side of transformer
- CN6: second side of transformer
- CN7: control port for outdoor fan motor ( not available for cooling only type )
- CN11: control port of live wire of electric heating
- CN12: connect the input of LED
- CN13: connect port of neutral wire of electric heating
- CN16: connect port of remote control detector
- CN18: live wire input port of PCB
- CN19: neutral wire input port of PCB
- CN20: outdoor compressor control terminal ( also can control outdoor fan motor for cooling only type )
- CN22: high speed control port of indoor fan motor
- CN23: middle speed control port of indoor fan motor

CN24: low speed control port of indoor fan motor

CN25: netural wire port of indoor fan motor

CN26: netural wire port of swing motor

CN27: control port of outdoor defrost sensor (not available for cooling only type)

CN28: low pressure switch

### 11.2 Sensor characteristic

| Model        | Name                        | Code        | Sub-part code | characteristic                   |
|--------------|-----------------------------|-------------|---------------|----------------------------------|
| HBU-18CF03   | Indoor ambient temp. sensor | 001A3900159 | 001A3900003   | R25=23KΩ±2.5%<br>B25/50=4200K±3% |
|              | Indoor coil temp. sensor    | 001A3900006 | 001A3900004   | R25=10KΩ±3%<br>B25/50=3700K±3%   |
| HDU-42CF03/H | Indoor coil temp. sensor    | 001A3800128 | 001A3900004   | R25=10KΩ±3%<br>B25/50=3700K±3%   |
|              | ambient temp. sensor        | /           | /             | /                                |
| HPU-42HF03   | Indoor ambient temp. sensor | 001A3800127 | 001A3900003   | R25=23KΩ±2.5%<br>B25/50=4200K±3% |
|              | Indoor coil temp. sensor    | 0010401922  | 001A3900004   | R25=10KΩ±3%<br>B25/50=3700K±3%   |
|              | Outdoor defrost sensor      | 0010401922  | 001A3900004   | R25=10KΩ±3%<br>B25/50=3700K±3%   |

| R25=23K Ω ±2.5%<br>B25/50=4200K±3% |          | R25=23K Ω ±2.5%<br>B25/50=4200K±3% |       |
|------------------------------------|----------|------------------------------------|-------|
| T(°C)                              | Rnom(KΩ) | 2°C                                | 74.67 |
| -20°C                              | 281.34   | 3°C                                | 70.65 |
| -19°C                              | 263.56   | 4°C                                | 66.88 |
| -18°C                              | 247.04   | 5°C                                | 63.33 |
| -17°C                              | 231.66   | 6°C                                | 60    |
| -16°C                              | 217.35   | 7°C                                | 56.86 |
| -15°C                              | 204.02   | 8°C                                | 53.91 |
| -14°C                              | 191.61   | 9°C                                | 51.13 |
| -13°C                              | 180.04   | 10°C                               | 48.51 |
| -12°C                              | 169.24   | 11°C                               | 46.04 |
| -11°C                              | 159.17   | 12°C                               | 43.72 |
| -10°C                              | 149.77   | 13°C                               | 41.52 |
| -9°C                               | 140.99   | 14°C                               | 39.45 |
| -8°C                               | 132.78   | 15°C                               | 37.5  |
| -7°C                               | 125.11   | 16°C                               | 35.66 |
| -6°C                               | 117.93   | 17°C                               | 33.92 |
| -5°C                               | 111.22   | 18°C                               | 32.27 |
| -4°C                               | 104.93   | 19°C                               | 30.72 |
| -3°C                               | 99.04    | 20°C                               | 29.25 |
| -2°C                               | 93.52    | 21°C                               | 27.86 |
| -1°C                               | 88.35    | 22°C                               | 26.54 |
| 0°C                                | 83.5     | 23°C                               | 25.3  |
| 1°C                                | 78.94    | 24°C                               | 24.12 |

|      |       |      |      |
|------|-------|------|------|
| 25°C | 23    | 48°C | 8.39 |
| 26°C | 21.94 | 49°C | 8.05 |
| 27°C | 20.94 | 50°C | 7.73 |
| 28°C | 19.99 | 51°C | 7.43 |
| 29°C | 19.09 | 52°C | 7.14 |
| 30°C | 18.23 | 53°C | 6.86 |
| 31°C | 17.42 | 54°C | 6.6  |
| 32°C | 16.65 | 55°C | 6.34 |
| 33°C | 15.92 | 56°C | 6.1  |
| 34°C | 15.22 | 57°C | 5.87 |
| 35°C | 14.56 | 58°C | 5.65 |
| 36°C | 13.93 | 59°C | 5.44 |
| 37°C | 13.34 | 60°C | 5.24 |
| 38°C | 12.77 |      |      |
| 39°C | 12.23 |      |      |
| 40°C | 11.71 |      |      |
| 41°C | 11.22 |      |      |
| 42°C | 10.76 |      |      |
| 43°C | 10.31 |      |      |
| 44°C | 9.89  |      |      |
| 45°C | 9.49  |      |      |
| 46°C | 9.1   |      |      |
| 47°C | 8.74  |      |      |

| R25=10K Ω ±3%<br>B25/50=3700K±3% |          | R25=10K Ω ±3%<br>B25/50=3700K±3% |       |
|----------------------------------|----------|----------------------------------|-------|
| T(°C)                            | Rnom(KΩ) |                                  |       |
| -20°C                            | 90.79    | 11                               | 18.43 |
| -19                              | 85.72    | 12                               | 17.61 |
| -18                              | 80.96    | 13                               | 16.83 |
| -17                              | 76.51    | 14                               | 16.09 |
| -16                              | 72.33    | 15                               | 15.38 |
| -15                              | 68.41    | 16                               | 14.71 |
| -14                              | 64.73    | 17                               | 14.08 |
| -13                              | 61.27    | 18                               | 13.48 |
| -12                              | 58.02    | 19                               | 12.9  |
| -11                              | 54.97    | 20                               | 12.36 |
| -10                              | 52.1     | 21                               | 11.84 |
| -9                               | 49.4     | 22                               | 11.34 |
| -8                               | 46.86    | 23                               | 10.87 |
| -7                               | 44.46    | 24                               | 10.43 |
| -6                               | 42.21    | 25                               | 10    |
| -5                               | 40.08    | 26                               | 9.59  |
| -4                               | 38.08    | 27                               | 9.21  |
| -3                               | 36.19    | 28                               | 8.84  |
| -2                               | 34.41    | 29                               | 8.48  |
| -1                               | 32.73    | 30                               | 8.15  |
| 0                                | 31.14    | 31                               | 7.83  |
| 1                                | 29.64    | 32                               | 7.52  |
| 2                                | 28.22    | 33                               | 7.23  |
| 3                                | 26.4     | 34                               | 6.95  |
| 4                                | 25.61    | 35                               | 6.68  |
| 5                                | 24.41    | 36                               | 6.43  |
| 6                                | 23.27    | 37                               | 6.18  |
| 7                                | 22.2     | 38                               | 5.95  |
| 8                                | 21.18    | 39                               | 5.73  |
| 9                                | 20.21    | 40                               | 5.52  |
| 10                               | 19.3     | 41                               | 5.32  |
|                                  |          | 42                               | 5.12  |

|    |      |    |      |
|----|------|----|------|
| 43 | 4.93 | 71 | 1.9  |
| 44 | 4.9  | 72 | 1.85 |
| 45 | 4.58 | 73 | 1.79 |
| 46 | 4.42 | 74 | 1.73 |
| 47 | 4.26 | 75 | 1.68 |
| 48 | 4.11 | 76 | 1.63 |
| 49 | 3.97 | 77 | 1.58 |
| 50 | 3.83 | 78 | 1.54 |
| 51 | 3.7  | 79 | 1.49 |
| 52 | 3.57 | 80 | 1.45 |
| 53 | 3.45 |    |      |
| 54 | 3.33 |    |      |
| 55 | 3.22 |    |      |
| 56 | 3.11 |    |      |
| 57 | 3.11 |    |      |
| 58 | 2.9  |    |      |
| 59 | 2.81 |    |      |
| 60 | 2.72 |    |      |
| 61 | 2.63 |    |      |
| 62 | 2.54 |    |      |
| 63 | 2.49 |    |      |
| 64 | 2.38 |    |      |
| 65 | 2.3  |    |      |
| 66 | 2.23 |    |      |
| 67 | 2.16 |    |      |
| 68 | 2.09 |    |      |
| 69 | 2.03 |    |      |
| 70 | 1.96 |    |      |

### 12. Air velocity distribution

#### 1) HBU-18CF03

##### a. Cooling / Air Velocity Distribution

Cooling

Blow angle: 40

Air Velocity Distribution

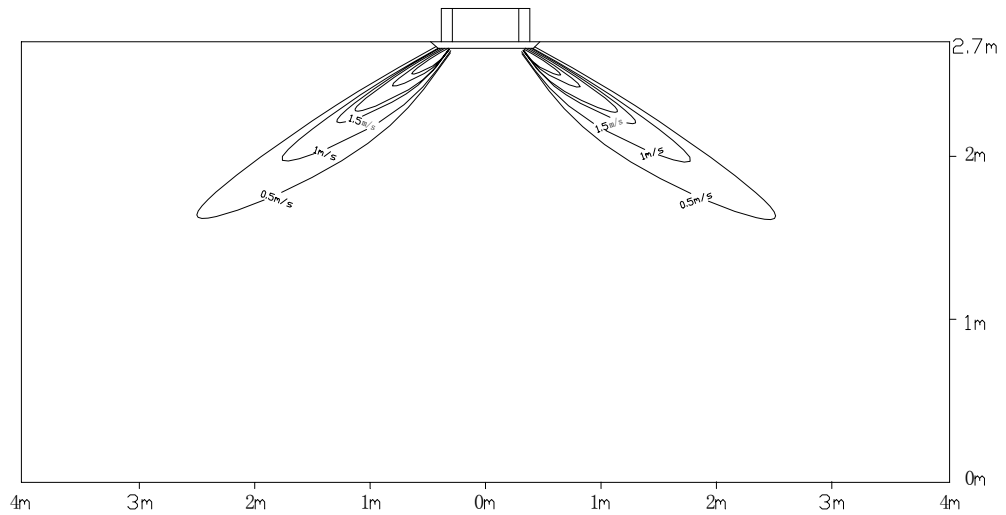

##### b. Cooling / Temperature Distribution

Cooling

Blow angle: 40

Temperature Distribution

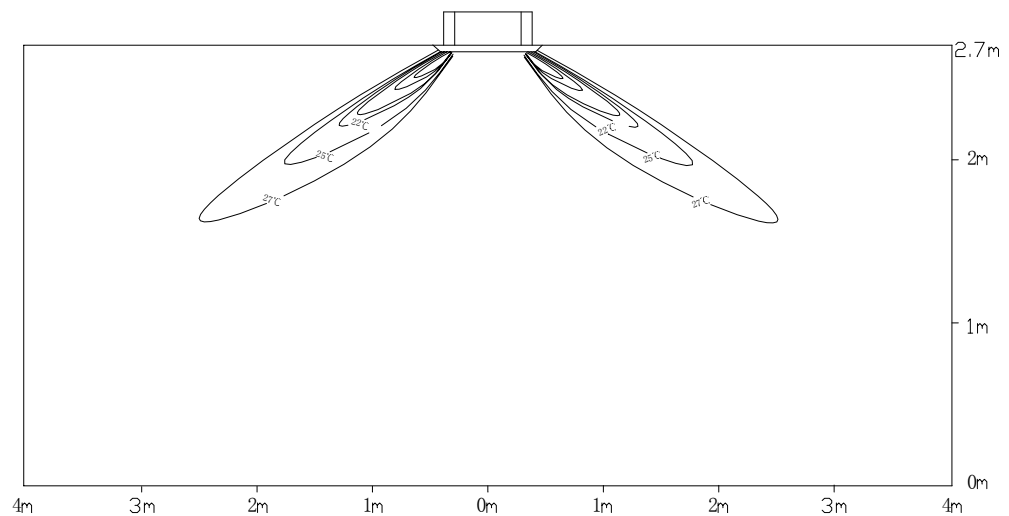



### 2) HDU-CF03/H

cooling  
air discharge angle 5°  
Air Velocity distribution

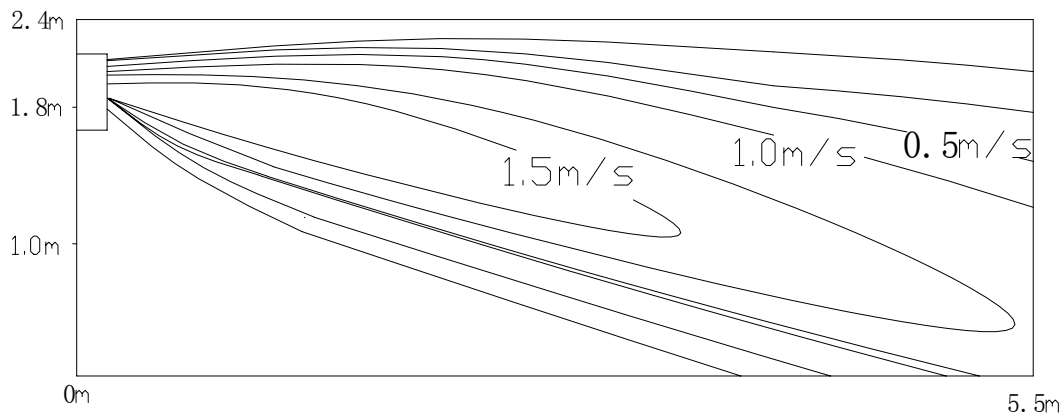

cooling  
air discharge angle 5°  
Temperature distribution

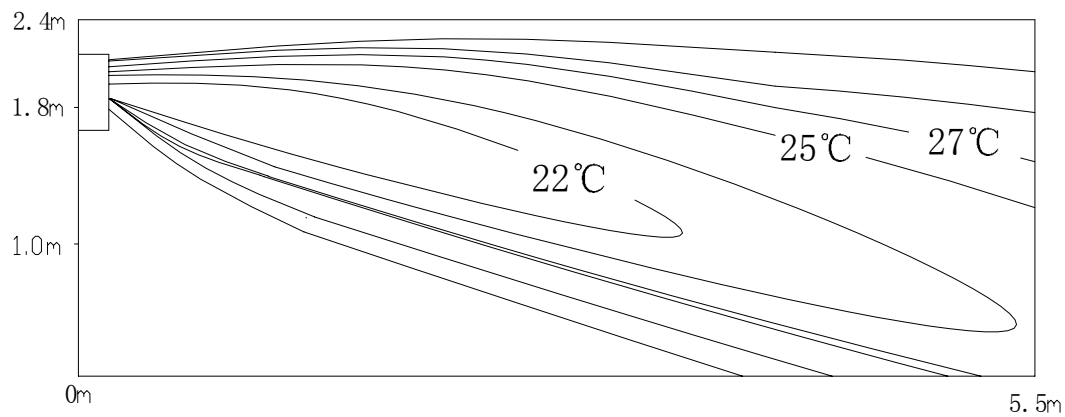

# Sincere Forever

## Haier Group

Haier Industrial Park, No.1, Haier Road

266101, Qingdao, China

<http://www.haier.com>



**Большая библиотека технической документации**

<https://splitsystema48.ru/instrukcii-po-ekspluatacii-kondicionerov.html>

**каталоги, инструкции, сервисные мануалы, схемы.**